

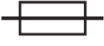











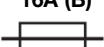



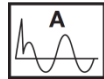
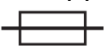

QUICKTRONIC® INTELLIGENT T5 DIM

	QTi 1x14/24 DIM	QTi 1x21/39 DIM	QTi 1x28/54 DIM	QTi 1x35/49/80 DIM
10A (B) 	17 x 	17 x 	17 x 	12 x 
16A (B) 	28 x 	28 x 	28 x 	19 x 
 A	≤ 24 A	≤ 24 A	≤ 24 A	≤ 28 A
T_H	174 μs	174 μs	174 μs	224 μs

	QTi 2x14/24 DIM	QTi 2x21/39 DIM	QTi 2x28/54 DIM	QTi 2x35/49 DIM	QTi 2x35/49/80 DIM	QTi 3x14 DIM	QTi 4x14 DIM
10A (B) 	12 x 	8 x 	8 x 	8 x 	5 x 	12 x 	8 x 
16A (B) 	19 x 	13 x 	13 x 	13 x 	9 x 	19 x 	13 x 
 A	≤ 35 A	≤ 45 A	≤ 45 A	≤ 45 A	≤ 60 A	≤ 35 A	≤ 45 A
T_H	180 μs	204 μs	204 μs	204 μs	230 μs	180 μs	205 μs

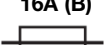
QTi 1x14/24 DIM; QTi 1x21/39 DIM; QTi 1x28/54 DIM; QTi 1x35/49/80 DIM

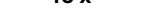
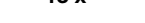
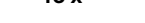
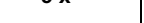
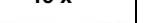
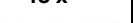
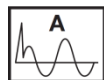
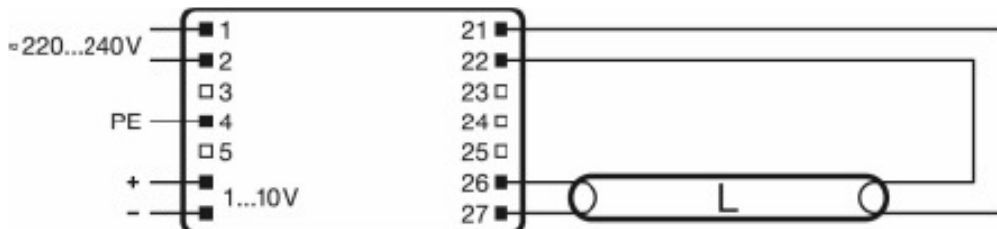

QTi 2x14/24 DIM; QTi 2x21/39 DIM; QTi 2x28/54 DIM; QTi 2x35/49 DIM; QTi 2x35/49/80 DIM

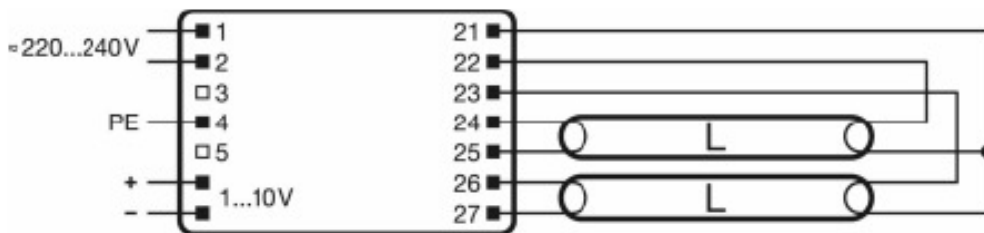

Max. permitted cable length between ECG and lamp: 1,5 m (PIN 21; 22), 1,0 m (PIN 24; 25; 26; 27)

- (D) Max. Leitungslänge zwischen EVG und Lampe; Leitungslänge max.
- (RUS) Макс.длина кабеля между прибором и лампой
- (KZ) Құрылғы мен шам арасындағы кабельдің максималды ұзындығы.

QTi 3x14/24 DIM

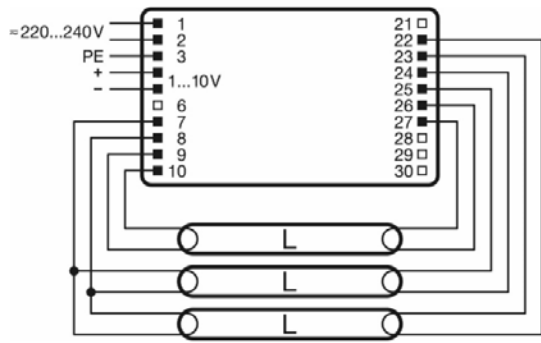

QTi 4x14/24 DIM

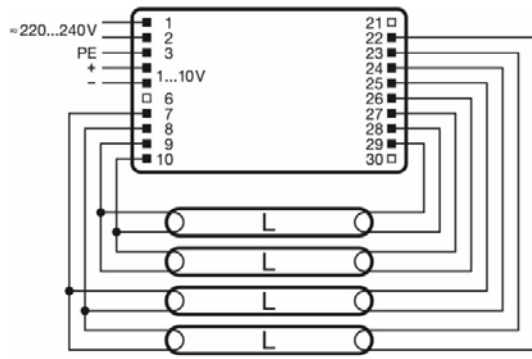

Max. permitted cable length between ECG and lamp: 1,0 m

- (D) Max. Leitungslänge zwischen EVG und Lampe; Leitungslänge max.
- (RUS) Макс.длина кабеля между прибором и лампой
- (KZ) Құрылғы мен шам арасындағы кабельдің максималды ұзындығы.

Temp	U _{in} [V]	I _{in} [A]	U _{out} [V]	I _{out} [A]	U _{out} [V]
1x14/24	220...240	0,17	0,50...80	0,05	+10...50
1x14/24	220...240	0,21	0,50...80	0,05	+10...50
1x14/24	220...240	0,30	0,50...80	0,05	+10...50

- (D) 1) Lampe; 2) Drahtvorbereitung; 3) Spannungsbereich AC/DC, Batteriespannungsbereich, Vorheizzeit, PE mit Gehäuse oder PIN 3/4 verbinden; 4) Dimmbereich; 5) Temperatur Testpunkt T_c; 6) Hergestellt in China; 7) Jahr; 8) Woche; 9) Wochentag (optional);
- (RUS) 1) Лампа; 2) Подготовка кабеля 3) Область применения AC/DC. Соединить защитный проводник с корпусом или PE; ; 4) Диапазон регулирования; 5) Температурный тест; 6) Сделано в Китае; 7) Год; 8) Не-деля; 9) день недели (опционально)
- (KZ) 1) Шам; 2) сымды дайындау; 3) Қолдану аясы AC / DC. Қорапты қорғаныш өткізгішін қосыңыз немесе PE; 4) реттеу диапазоны; 5) Температура тесті; 6) Қытайда жасалған; 7) Жыл; 8) Апта; 9) Жұмыс күндері (таңдаулы)

- © Εισαγωγή & διάθεση: OSRAM ΑΕ. Λ. Αθηνών 31-33, 104 47 Αθήνα
- © Производитель/Өндіруші: OSRAM GmbH, Марсель-Бройер-штрассе 6, 80807 Мюнхен, Германия. Импортер/Импорртаушы: ОАО «ОСРАМ» 214020 г. Смоленск/Смоленск қ., ул. Индустриальная 9-А/Индустриальная к., 9-А, тел.: +7 (4812) 62-86-00
- © Forgalmazó: OSRAM a.s. Mo-i Fióktelepe, 1119 Bp., Fehérvári út 84/A
- © Importer: OSRAM sp. z o.o., ul. Wiertnicza 117, 02-952 Warszawa
- © İthalatçı: OSRAM Aydınlatma Tic. A.Ş., Nispetiye Mah., Başlık Sok., MM Plaza, No:3 K:2, Etiler Beşiktaş İstanbul, +90 212 306-9000
- © OSRAM Romania SRL, Soseaua Bucuresti Nord Nr. 10, Global City Business Park, Cladirea O21, etaj 10, 077190 Voluntari, judetul Ilfov
- © Производитель: OSRAM GmbH, Доставка: ОСРАМ ЕООД, 1505 София, бул. Ситняково 48, офис 604, +359 - (0)2 - 9712262
- © Uvoznik: OSRAM d.o.o., Đorđa Stanojevića 14, 11070 Beograd, Srbija
- © Виробник: OSRAM GmbH, 80920 Мюнхен, Німеччина. Імпортер: ПІІ „ОСРАМ Україна“, вул. Димитрова, 5, 03150 Київ, Україна



05.03.15

OSRAM GmbH
Steinerne Furt 62
86167 Augsburg
Germany
www.osram.com
www.osram.ru/EAC