

Rozdzielnica SB-108705



Budowa symbolu zamówieniowego

SB-108705-	S	<input type="text"/>	-	<input type="text"/>
				Stopień ochrony
				54 IP54
				66 IP66
				Nr wykonania rozdzielnicy
				0000, 0010, 0020, 0030, 0040
				0050, 0060, 0070, 0080, 0090
				0100, 0110, 0120, 0130, 0140
				0150, 0160, 0170, 0180, 0190
				0200
				Typ gniazda
	S			Skośne*

Istnieje możliwość zamówienia gniazd jednofazowych w wersji SCHUKO. Należy wtedy dopisać „S” (SB-108705-S...-S).

* Standardowo montowane są gniazda skośne. Można zamówić gniazda proste wpisując literę „P” zamiast „S”.

Dane techniczne

Napięcie znamionowe	400/230 V (50 Hz)
Napięcie znamionowe izolacji U_i	500 V
Napięcie znamionowe udarowe wytrzymałalne U_{imp}	4 kV
Prąd znamionowy zestawu I_{nA}	32/63 A
Stopień ochrony	IP54 / IP66
Klasa ochronności	II
Przekrój przewodów przyłączeniowych	maks. $5 \times 6 \text{ mm}^2$ (PG21) dla 32 A maks. $5 \times 16 \text{ mm}^2$ (PG29) dla 63 A
Ilość modułów	10

Wymiary

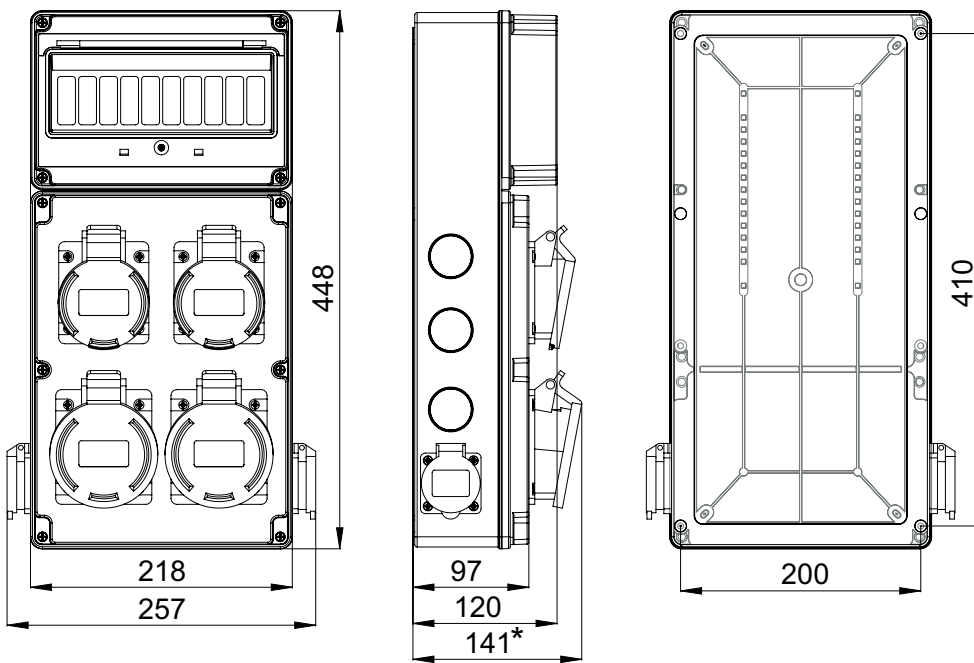

*) Dla gniazda 32 A

Wykonania

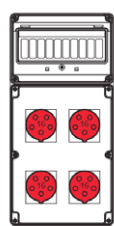

SB-108705-S0010

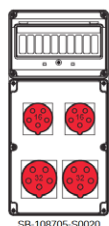

SB-108705-S0020

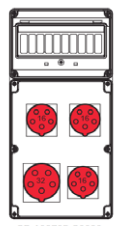

SB-108705-S0030

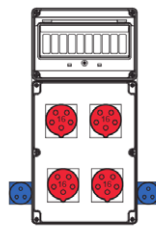

SN-108705-S0040

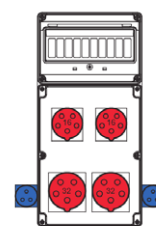

SB-108705-S0050

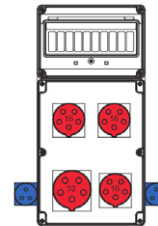

SB-108705-S0060

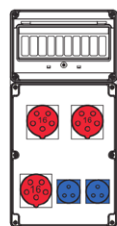

SB-108705-S0070

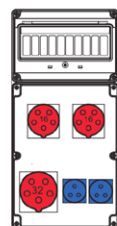

SB-108705-S0080

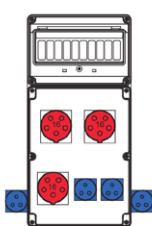

SB-108705-S0090

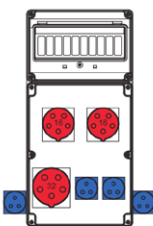

SB-108705-S0100

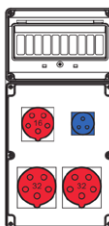

SB-108705-S0110

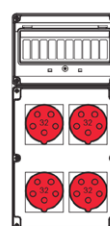

SB-108705-S0120

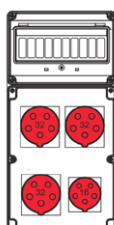

SB-108705-S0130

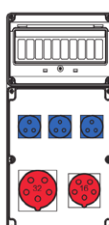

SB-108705-S0140

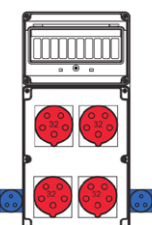

SB-108705-S0150

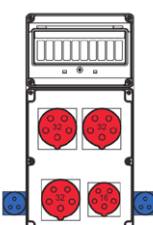

SB-108705-S0160

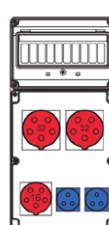

SB-108705-S0170

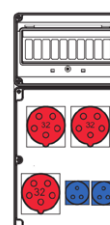

SB-108705-S0180

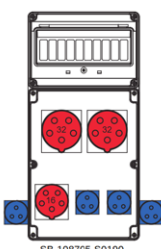

SB-108705-S0190

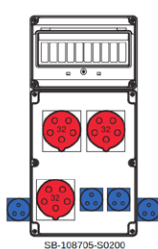

SB-108705-S0200