

PCE data sheet

article#	583-12v
article description	CEE-wall mounted plug 16A 3p 42VAC 50/60Hz IP44 TWIST
description long	CEE-wall mounted plug 16A 3p 42VAC 50/60Hz IP44 TWIST housing material: PA6 rated current: 16A number of poles: 3 (3P) clock-position: 12h rated voltage/frequency: 42V~ / 50+60Hz contacts: brass nickel plated connection technology: screw terminals IP protection class: IP44
GTIN (EAN)	9003399063695
country of origin	AT
customs number	85366990
net weight	0.194 kg
packaging quantity	10
minimum order quantity	10

ETIM 7.0	EC001319
IEC-amperage	16 A
Voltage acc. EN 60309-2	40-50 V (50+60 Hz) white
Number of poles	3
Clock hour position	12 h
Identification colour	White
Degree of protection (IP)	IP44
Connection system	Screwed terminal
Construction type	Surface mounted plug
Angle of plug	Angled
Material	Plastic

a	106 mm
wire flexible	4-10 mm ²
wire solid	4-10 mm ²
contact screws	110 Ncm
dismantling length	70 mm
stripping length	14-16 mm

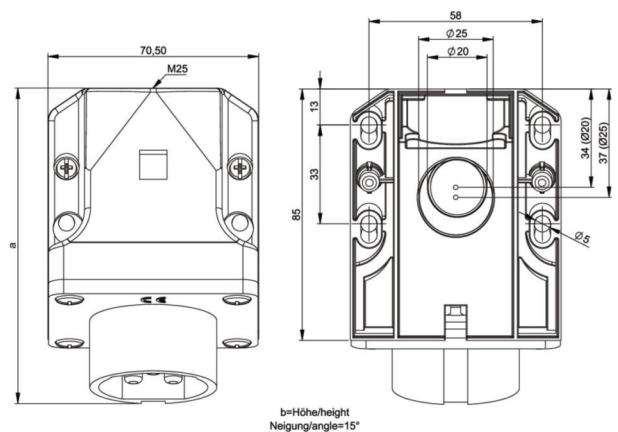

www.manufacturer-safety.info