

PCE data sheet

article#	540252001
article description	CEE-motor protection plug (PKZM0) +BA 32A 5p 6h (16-20A) IP44
description long	CEE-motor protection plug (PKZM0) +BA 32A 5p 6h (16-20A) IP44 housing material: PC/ABS rated current: 32A number of poles: 5 (3P+N+PE) clock-position: 6h rated voltage/frequency: 200/346V~ - 240/415V~ / 50+60Hz contacts: brass nickel plated connection technology: screw terminals rotary lever, motor setting range: 16A - 20A operating display, cable gland: M32 IP protection class: IP44
GTIN (EAN)	9003399670640
country of origin	AT
customs number	85366990
net weight	0.892 kg
packaging quantity	1

ETIM 7.0	EC000452
Type of motor protection	Thermal release
Type of control element	Rotary toggle
Phase inverter	False
Phase sequence monitoring	False
Adjustable current range	16 - 20 A
Colour plug	Red
Colour housing	Grey
Rated voltage	400 V
Rated permanent current Iu	32 A

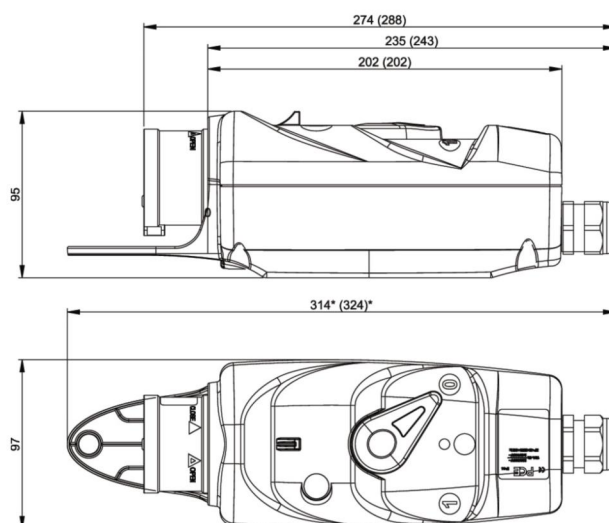

www.manufacturer-safety.info