

# PCE data sheet

article#	<b>56104000</b>
article description	<b>Motor protection plug (nat) 4A 230V IP44 (I-0)</b>
description long	Motor protection plug (nat) 4A 230V IP44 (I-0) housing material: PC/ABS rated current: 16A number of poles: 3 (2P+PE) rated voltage/frequency: 230V~ / 50+60Hz contacts: brass nickel plated connection technology: screw terminals switch: OFF-ON (0-I) 2x cable glands M16, for use of external float switch IK-standard acc. EN50102: IK09 IP protection class: IP44
GTIN (EAN)	9003399648694
country of origin	AT
customs number	85366990
net weight	0.202 kg
packaging quantity	2

ETIM 7.0	EC000452
Type of motor protection	Thermal release
Type of control element	Push button switch
Adjustable current range	4 A
Colour housing	Grey
Rated voltage	230 V
Rated permanent current lu	4 A

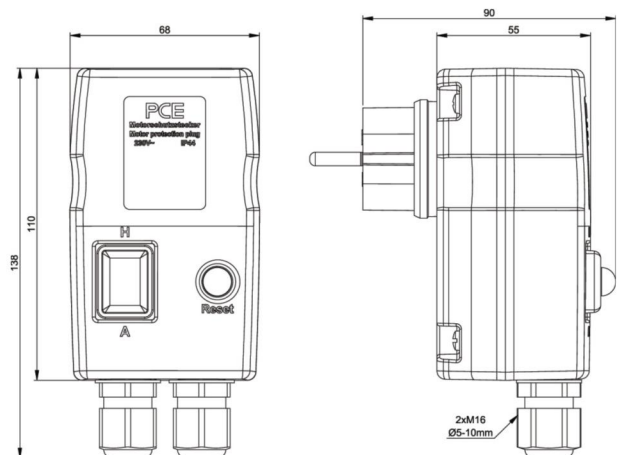

[www.manufacturer-safety.info](http://www.manufacturer-safety.info)