

## PCE data sheet

article#	<b>3132-9f9</b>
article description	<b>CEE-flanged socket straight (54x60mm) 16A 3p 9h IP67</b>
description long	CEE-flanged socket straight (54x60mm) 16A 3p 9h IP67 housing material: PA6 rated current: 16A number of poles: 3 (2P+PE) clock-position: 9h rated voltage/frequency: 380-415V~ / 50+60Hz contacts: brass connection technology: screw terminals dimensions (flange/fixing center): 54x60 mm / 44x44 mm IP protection class: IP67
country of origin	AT
customs number	85366990

ETIM 7.0	EC001317
IEC-amperage	16 A
Voltage acc. EN 60309-2	380-415 V (50+60 Hz) red
Number of poles	3
Clock hour position	9
Identification colour	Red
Degree of protection (IP)	IP67
Connection system	Screwed terminal
Angle of plug	Straight
Material	Plastic
Contact material	CuZn
Surface finish contacts	Untreated
Flange size vertical	60 mm
Drill hole distance vertical	44 mm
Flange size horizontal	54 mm
Drill hole distance horizontal	44 mm

wire flexible	1-2,5 mm <sup>2</sup>
wire solid	1-4 mm <sup>2</sup>
contact screws	100 Ncm
dismantling length	50 mm
stripping length	10-12 mm

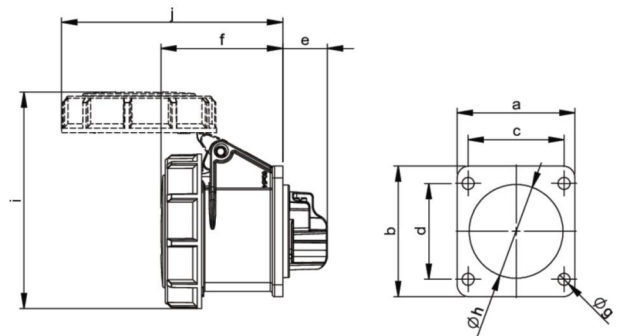

[www.manufacturer-safety.info](http://www.manufacturer-safety.info)