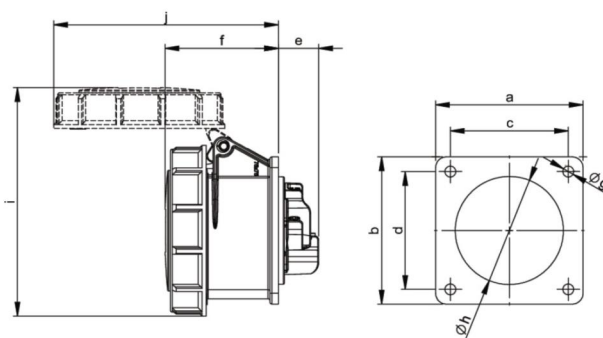

PCE data sheet

article#	3142-4
article description	CEE-flanged socket straight (75x75mm) 16A 4p 4h IP67
description long	CEE-flanged socket straight (75x75mm) 16A 4p 4h IP67 housing material: PA6 rated current: 16A number of poles: 4 (3P+PE) clock-position: 4h rated voltage/frequency: 100-130V~ / 50+60Hz contacts: brass connection technology: screw terminals dimensions (flange/fixing center): 75x75 mm / 60x60 mm IP protection class: IP67
GTIN (EAN)	9003399135156
country of origin	AT
customs number	85366990
net weight	0.153 kg
packaging quantity	10

ETIM 7.0	EC001317
IEC-amperage	16 A
Voltage acc. EN 60309-2	110 V (50+60 Hz) yellow
Number of poles	4
Clock hour position	4
Identification colour	Yellow
Degree of protection (IP)	IP67
Connection system	Screwed terminal
Angle of plug	Straight
Material	Plastic
Contact material	CuZn
Surface finish contacts	Untreated
Flange size vertical	75 mm
Drill hole distance vertical	60 mm
Flange size horizontal	75 mm
Drill hole distance horizontal	60 mm

wire flexible	1-2,5 mm ²
wire solid	1-4 mm ²
contact screws	100 Ncm
dismantling length	50 mm
stripping length	10-12 mm

www.manufacturer-safety.info