

PCE data sheet

article#	77725-7
article description	CEE-flanged plug angled 32A 5p 7h IP44
description long	CEE-flanged plug angled 32A 5p 7h IP44 housing material: PC/ABS rated current: 32A number of poles: 5 (3P+N+PE) clock-position: 7h rated voltage/frequency: 277/480V~ - 288/500V~ / 50+60Hz contacts: brass connection technology: screw terminals IP protection class: IP44
GTIN (EAN)	9003399714078
country of origin	AT
customs number	85366990
net weight	0.247 kg
packaging quantity	5

ETIM 7.0	EC001319
IEC-amperage	32 A
Voltage acc. EN 60309-2	500 V (50+60 Hz) black
Number of poles	5
Clock hour position	7 h
Identification colour	Black
Degree of protection (IP)	IP44
Connection system	Screwed terminal
Construction type	Built-up device plug
Angle of plug	Angled
Material	Plastic
Contact material	CuZn
Surface finish contacts	Untreated

wire flexible	2,5-6 mm ²
wire solid	2,5-10 mm ²
contact screws	110 Ncm
dismantling length	50 mm
stripping length	12-14 mm

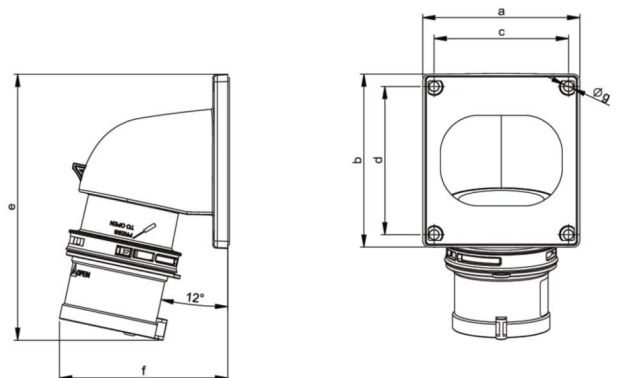

www.manufacturer-safety.info