

PCE data sheet

article#	777132-6tt
article description	CEE-flanged plug angled 16A 3p 6h IP67 TT
description long	CEE-flanged plug angled 16A 3p 6h IP67 TT housing material: PC/ABS rated current: 16A number of poles: 3 (2P+PE) clock-position: 6h rated voltage/frequency: 200-250V~ / 50+60Hz contacts: brass connection technology: screwless terminals (TT) IP protection class: IP67
GTIN (EAN)	9003399729225
country of origin	AT
customs number	85366990
net weight	0.149 kg
packaging quantity	10

ETIM 7.0	EC001319
IEC-amperage	16 A
Voltage acc. EN 60309-2	230 V (50+60 Hz) blue
Number of poles	3
Clock hour position	6 h
Identification colour	Blue
Degree of protection (IP)	IP67
Connection system	Screw less terminal
Construction type	Built-up device plug
Angle of plug	Angled
Material	Plastic
Contact material	CuZn
Surface finish contacts	Untreated

wire flexible	1-2,5 mm ²
wire solid	1-4 mm ²
dismantling length	50 mm
stripping length	10-12 mm

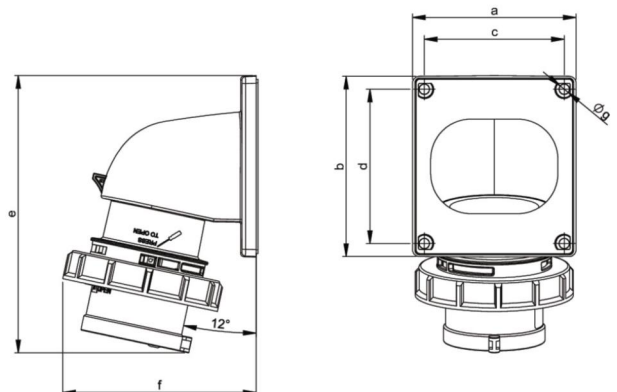

www.manufacturer-safety.info