

PCE data sheet

article#	214-4tt
article description	CEE-connector 16A 4p 4h IP44/IP54 SHARK TT
description long	CEE-connector 16A 4p 4h IP44/IP54 SHARK TT housing material: PA6 rated current: 16A number of poles: 4 (3P+PE) clock-position: 4h rated voltage/frequency: 100-130V~ / 50+60Hz contacts: brass connection technology: screwless terminals (TT) IP protection class: IP44/IP54
GTIN (EAN)	9003399693571
country of origin	AT
customs number	85366990
net weight	0.161 kg
packaging quantity	10
minimum order quantity	10

ETIM 7.0	EC001320
IEC-amperage	16 A
Number of poles	4
Voltage acc. EN 60309-2	110 V (50+60 Hz) yellow
Clock hour position	4 h
Identification colour	Yellow
Degree of protection (IP)	IP44
Connection system	Screw less terminal
Angle of plug	Straight
Cable entry	Swivel
Material	Plastic
Contact material	CuZn
Surface finish contacts	Untreated

a	138 mm
b	82 mm
K (cable Ø)	6-15 mm
SW	42 mm
wire flexible	1-2,5 mm ²
strain relief	500 Ncm
dismantling length	50 mm
stripping length	10-12 mm

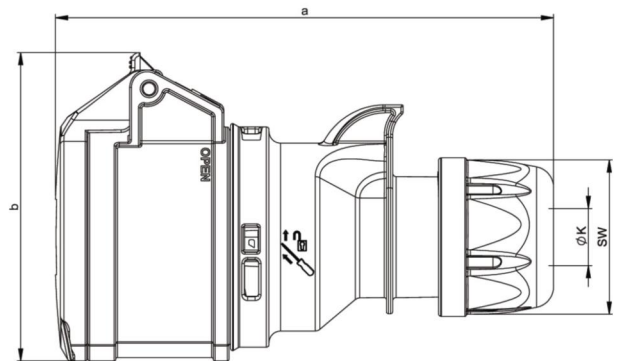

www.manufacturer-safety.info