

PCE data sheet

article#	6114-6
article description	CEE-switched interlocked socket compact 16A 4p 6h IP44/IP54
description long	CEE-switched interlocked socket compact 16A4p 6h IP44/IP54 housing material: PA6 + PC/ABS rated current: 16A number of poles: 4 (3P+PE) clock-position: 6h rated voltage/frequency: 380-415V~ / 50+60Hz contacts: brass nickel plated connection technology: screw terminals wall mounting, mechanical interlock switch: ON/OFF PCE-Merz ML0; EN 60947-3; AC22A, 10kA IP protection class: IP44/IP54
GTIN (EAN)	9003399174575
country of origin	AT
customs number	85366990
net weight	0.636 kg
packaging quantity	1

ETIM 7.0	EC001324
IEC-amperage	16 A
Number of poles	4
Voltage acc. EN 60309-2	400 V (50+60 Hz) red
Clock hour position	6 h
Identification colour	Red
Degree of protection (IP)	IP54
Switch	Mechanical locking
Material housing	Plastic
Model	Base unit and cover
Contact material	CuZn
Surface finish contacts	Nickel-plated

wire flexible	1,5-2,5 mm ²
wire solid	1,5-4 mm ²

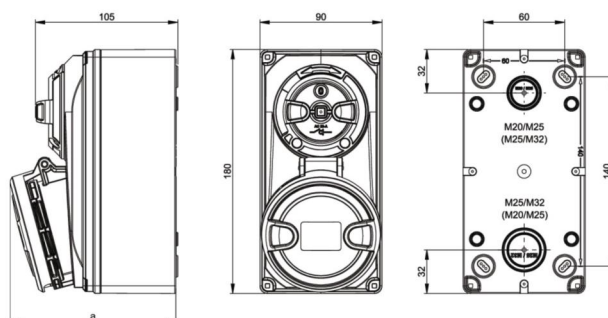

www.manufacturer-safety.info