

wymiary w [mm]  
dimensions [mm]

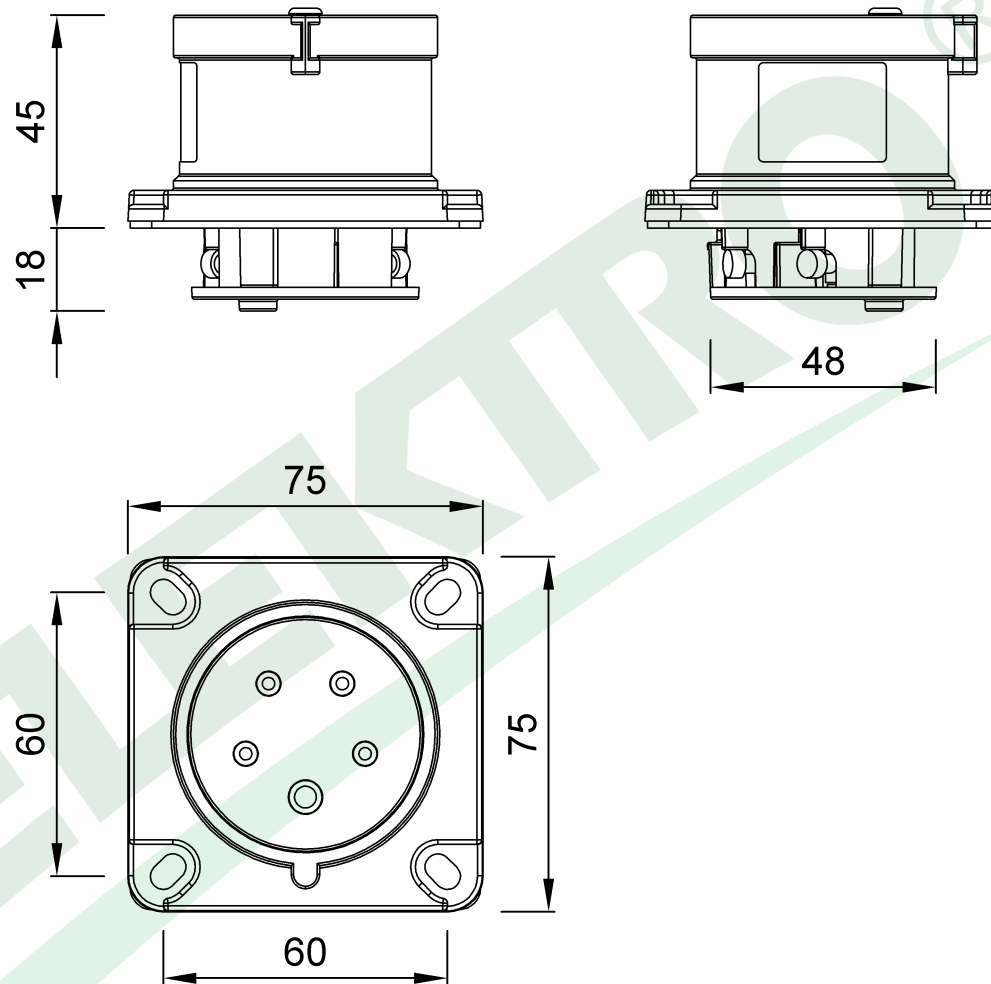

**PARAMETRY  
PARAMETERS**

napięcie voltage	380V-415V
natężenie prądu current	16A
częstotliwość frequency	50Hz-60Hz
ilość pól number of poles	5 (3P+N+E)
stopień ochrony international protection	IP44

F7.0059	Wtyk siłowy tablicowy odbiornikowy 16A 5p 380V-415V IP44 Panel Mounted Plug 16A 5p 380V-415V IP44
F-ELEKTRO www.f-elektro.com, e-mail: info@f-elektro.com	