

wymiary w [mm]
dimensions [mm]

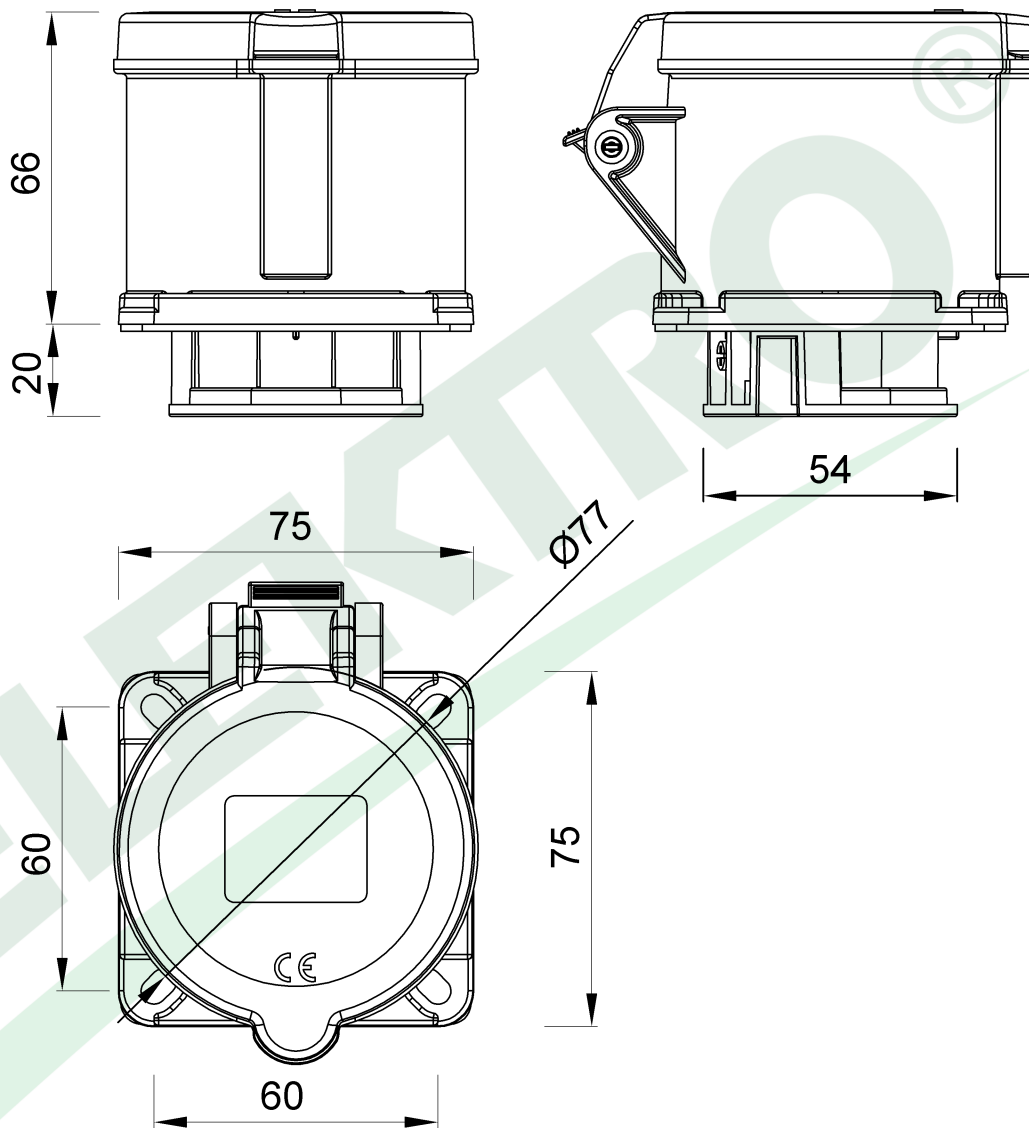

**PARAMETRY
PARAMETERS**

napięcie voltage	380V-415V
natężenie prądu current	32A
częstotliwość frequency	50Hz-60Hz
ilość pól number of poles	5 (3P+N+E)
stopień ochrony international protection	IP44

F7.0082 Gniazdo tablicowe proste 32A 5p 380V-415V IP44
Panel Mounted Socket 32A 5p 380V-415V IP44

F-ELEKTRO
www.f-elektro.com,
e-mail: info@f-elektro.com