

wymiary w [mm]
dimensions [mm]

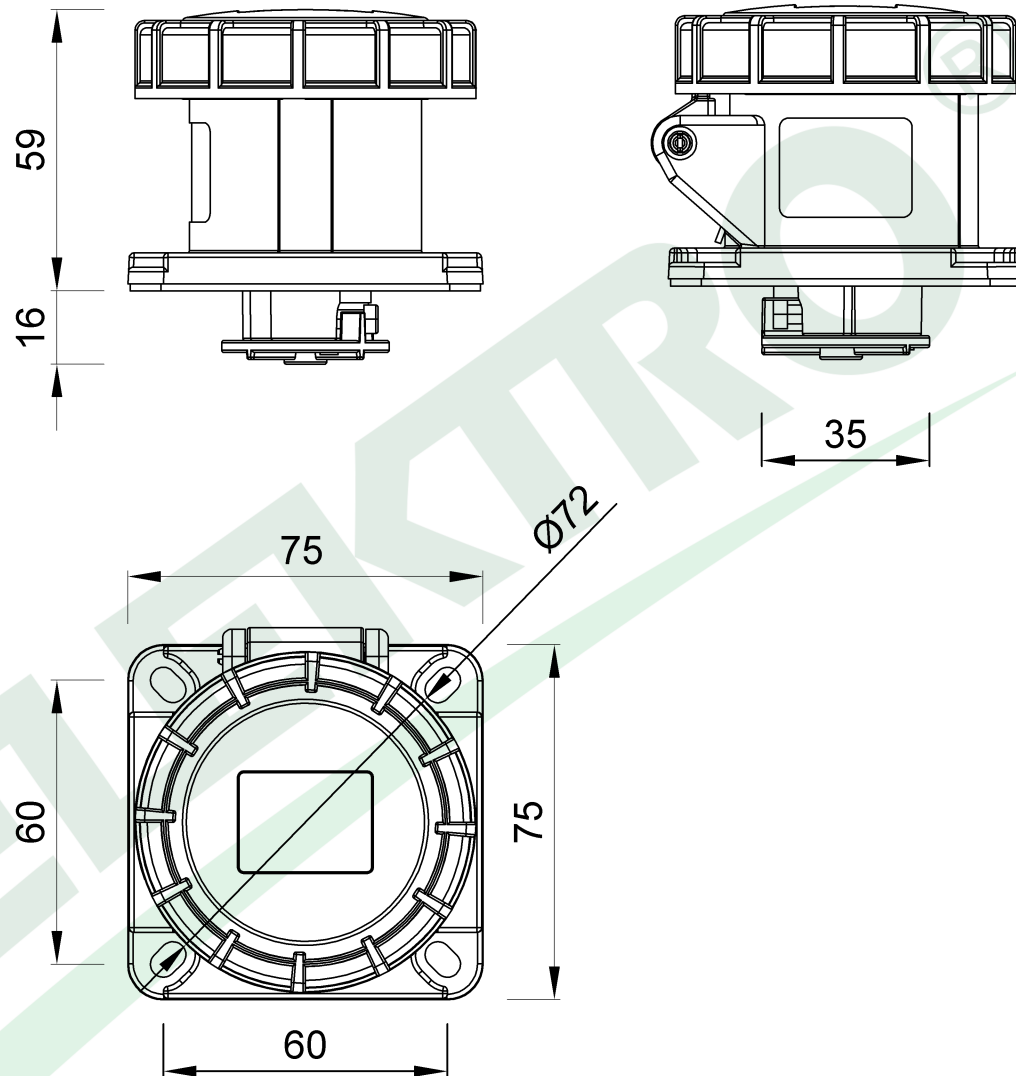

**PARAMETRY
PARAMETERS**

napięcie voltage	200V-250V
natężenie prądu current	16A
częstotliwość frequency	50Hz-60Hz
ilość pól number of poles	3 (2P+E)
stopień ochrony international protection	IP67

F7.0153 Gniazdo przemysł. tablicowe proste 16A 3p 200V-250V IP67 - czarne
Panel Mounted Socket 16A 3p 200V-250V IP67 - black

F-ELEKTRO
www.f-elektro.com,
e-mail: info@f-elektro.com