

wymiary w [mm]
dimensions [mm]

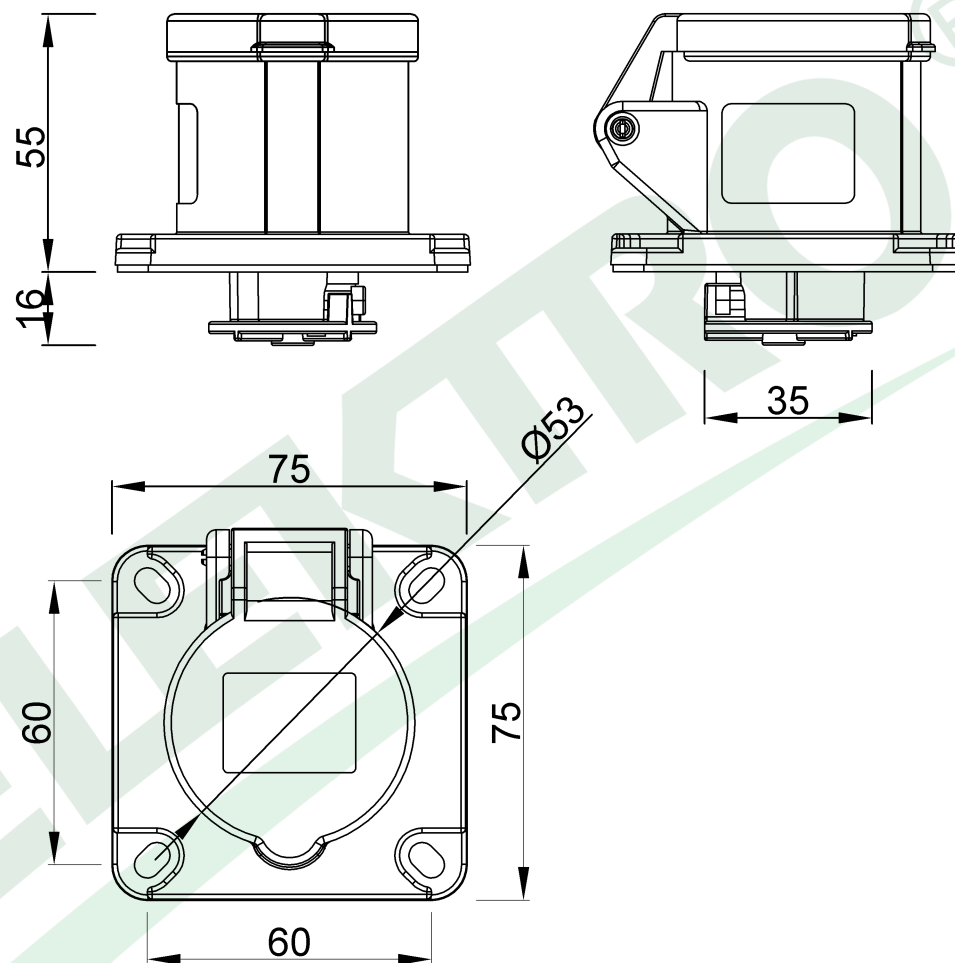

**PARAMETRY
PARAMETERS**

napięcie voltage	200V-250V
natężenie prądu current	16A
częstotliwość frequency	50Hz-60Hz
ilość pól number of poles	3 (2P+E)
stopień ochrony international protection	IP44

F7.0151	Gniazdo przemysł. tablicowe proste 16A 3p 200V-250V IP44 - czarne Panel Mounted Socket 16A 3p 200V-250V IP44 - black
F-ELEKTRO www.f-elektro.com, e-mail: info@f-elektro.com	