

wymiary w [mm]
dimensions [mm]

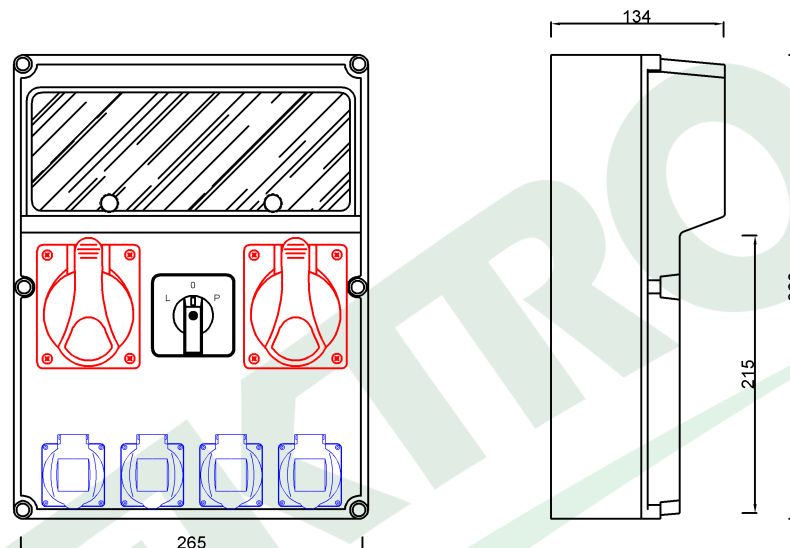

PARAMETRY PARAMETERS	
obudowa box	IP65
gniazda sockets	IP44
dławica cable gland	PG16
zaciski terminal	N i PE
wyłącznik switch	L/P(32A)
OKABLOWANIE GNIAZD Sockets wiring	
32A/5p	4mm ² H07V-K /LgY/ 450/750V
230V	1.5mm ² H07V-K /LgY/ 450/750V

74183.88 Roz. FEMO 13M 2x32/5, 4x230V, L/P(32A) IP44
Distribution box FEMO 13M 2x32/5, 4x230V, L/R(32A) IP44

F-ELEKTRO
www.f-elektro.com,
e-mail: info@f-elektro.com