

wymiary w [mm]
dimensions [mm]

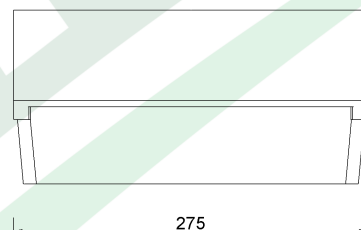
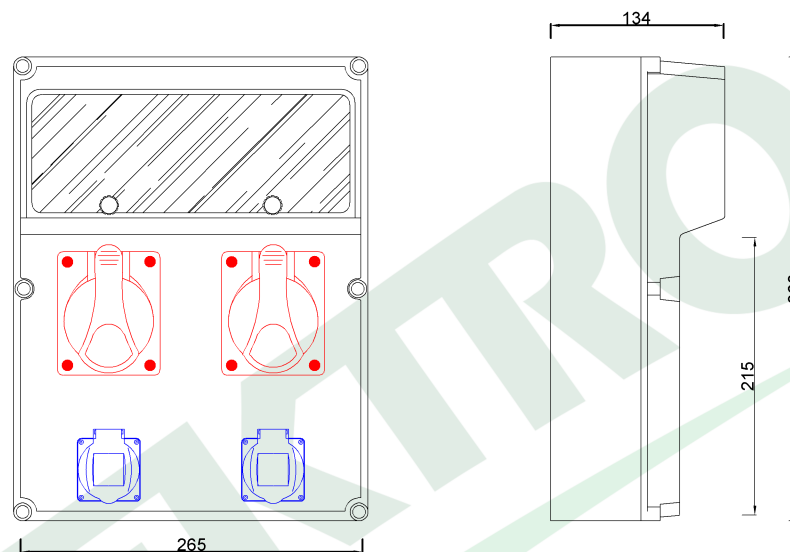

PARAMETRY PARAMETERS	
obudowa box	IP65
gniazda sockets	IP44
dławica cable gland	PG16
zaciski terminal	N i PE
OKABLOWANIE GNIAZD Sockets wiring	
32A/5p	4mm ² H07V-K /LgY/ 450/750V
230V	1.5mm ² H07V-K /LgY/ 450/750V

74183.46 Roz. FEMO 13M 2x32/5, 2x230V IP44
Distribution box FEMO 13M 2x32/5, 2x230V IP44

F-ELEKTRO
www.f-elektro.com,
e-mail: info@f-elektro.com