

wymiary w [mm]
dimensions [mm]

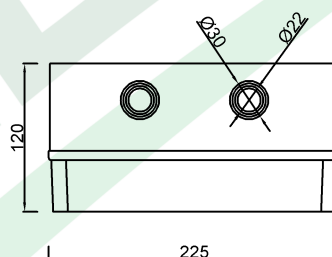
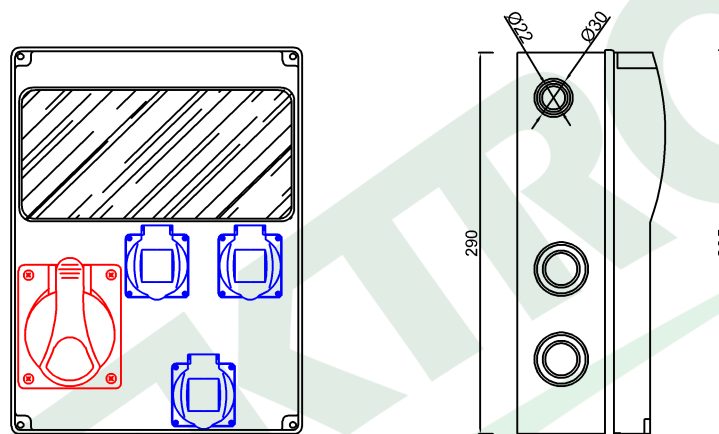

PARAMETRY PARAMETERS	
obudowa box	IP54
gniazda sockets	IP44
zaciski terminal	N i PE
dławica cable gland	PG16
OKABLOWANIE GNIAZD Sockets wiring	
16A/5p	2.5mm ² H07V-K /LgY/ 450/750V
230V	1.5mm ² H07V-K /LgY/ 450/750V

74184.9 Roz. ULISSE 11M 16/5, 3x230V
Distribution box ULISSE 11M 16/5, 3x230V

F-ELEKTRO
www.f-elektro.com,
e-mail: info@f-elektro.com