

wymiary w [mm]
dimensions [mm]

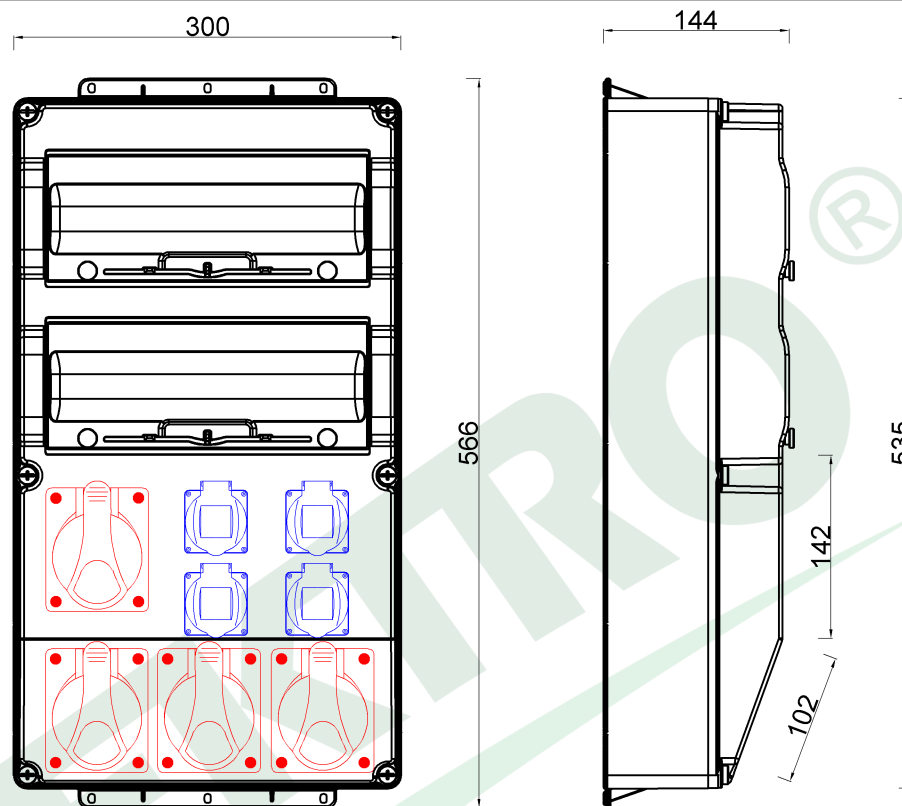

PARAMETRY PARAMETERS	
obudowa box	IP66
gniazda sockets	IP44
dławica cable gland	PG36
zaciski terminal	N i PE
OKABLOWANIE GNIAZD Sockets wiring	
32A/5p	4mm ² H07V-K /LgY/ 450/750V
230V	1.5mm ² H07V-K /LgY/ 450/750V

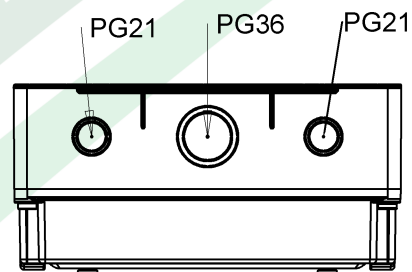

F3.0824 Roz. CAJA 26m 4x32/5, 4x230V IP44
Distribution box CAJA 26m 4x32/5, 4x230V IP44

F-ELEKTRO
www.f-elektro.com,
e-mail: info@f-elektro.com