

wymiary w [mm]
dimensions [mm]

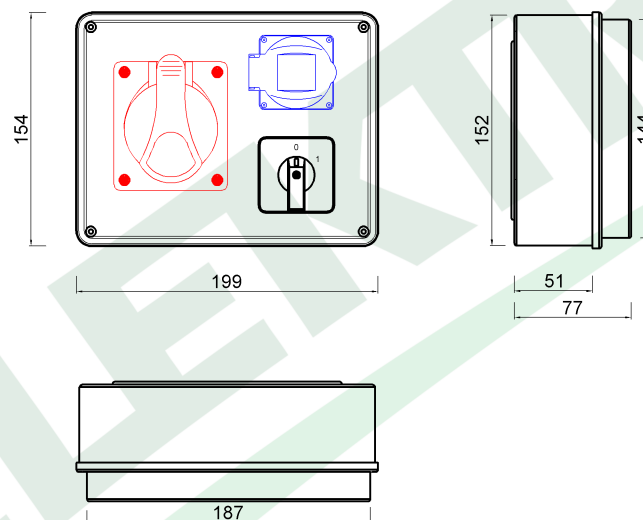

PARAMETRY PARAMETERS	
obudowa box	IP56
gniazda sockets	IP44
wyłącznik switch	0/1 (16A)
dławica cable gland	PG16
listwa zaciskowa terminal	10 mm ²
OKABLOWANIE Sockets wiring	
16A/5p	2.5mm ² H07V-K /LgY/ 450/750V
230V	1.5mm ² H07V-K /LgY/ 450/750V

F3.0087 Roz. R-190 16/5, 230V, 0/1(16A) IP44
Distribution box R-190 16/5, 230V, 0/1(16A) IP44

F-ELEKTRO
www.f-elektro.com,
e-mail: info@f-elektro.com