

LED Flood Light IP65– 50W

Authorized Licensee for TOSHIBA trademark



1. Specification:

A. General Data

Model	LED Flood Light 50W			
P/N(Black shell)	DELL-FL34050C5A011	DELL-FL44050C5A011	DELL-FL54050C5A011	DELL-FLC4050C5A011
Westnet Code	00172843	00172842	00172841	00172840
P/N(White shell)	DELL-FL34050C5A021	DELL-FL44050C5A021	DELL-FL54050C5A021	DELL-FLC4050C5A021
Westnet Code	00173315	00172314	00172313	00172312
Rated Voltage	230 VAC	230 VAC	230 VAC	230 VAC
Frequency	50/60 Hz	50/60 Hz	50/60 Hz	50/6 Hz
Rated Wattage	50 W	50 W	50 W	50 W
Deviation Tolerance of Wattage	±10 %	±10 %	±10 %	±10 %
Displacement factor (cos φ1)*	0.9(typical)	0.9(typical)	0.9(typical)	0.9(typical)
Rated Current	0.213A	0.213A	0.213A	0.213A
Maximum Input Current	0.245A	0.245A	0.245A	0.245A
Start On	<0.5S	<0.5S	<0.5S	<0.5S
Warm up time	<1S	<1S	<1S	<1S
Dimmable	NO	NO	NO	NO
Beam Angle	120°	120°	120°	120°
Peak luminous intensity (cd)	1810	1810	1810	1810

R9 CRI	>1	>1	>1	>1
Survival factor	90%	90%	90%	90%
Safety requirements	CE	CE	CE	CE
Lumen Maintenance factor	96%	96%	96%	96%
Stroboscopic effect metric (SVM)**	No Claimed	No Claimed	No Claimed	No Claimed
Flicker metric (PstLM)**	No Claimed	No Claimed	No Claimed	No Claimed
Energy Efficiency Class(EEC)	F	F	F	F
Applicable Environments	IP65	IP65	IP65	IP65
Exchangeable LED Module	NO	NO	NO	NO
Photobiological Group	RG 0	RG 0	RG 0	RG 0
Safety class	Class I	Class I	Class I	Class I

* Displacement factor tolerance +/- 10%

**In accordance with (EU)2019/2020 of SVM $\leq 0,4$ at full-load (except for HID with $\Phi_{use} > 4$ km and for light sources intended for use in outdoor applications, industrial applications or other applications where lighting standards allow a CRI < 80)

B. Light Data

Color	Warm White	Natural White	Daylight	Cool White
Color Temperature (CCT)	3000K	4000K	5000K	6500K
Useful luminous flux*	4050 lm			
Total luminous flux*	4500 lm			
Color Rendering Index*	80			
Efficacy (Useful)*	81 lm/W	81 lm/W	81 lm/W	81 lm/W
Efficacy (Total)*	90 lm/W	90 lm/W	90 lm/W	90 lm/W
Color Consistency**	6 Step MacAdam Ellipse (6 SDCM)			

* tolerance +/- 10%

** 3000K center point (0.43387, 0.40319) ; 4000K center point (0.38177, 0.37959) ; 5000K center point (0.34464, 0.35506) ; 6500K center point (0.31230, 0.32825)

C. Lifetime

(Supplied Voltage: AC 230V ; Ambient Temperature: 25°C)

Lumen Maintenance Factor	70% of the rated lifetime
Rated Lifetime – L₇₀B₅₀	15,000 hrs
Switch cycles	≥ 15,000

D. Temperature Operation

Normal operation temperature	-20°C ~ 40°C
Relative Humidity	10% ~ 90%

E. Geometric Data

Model	LED Flood Light 50W
Maximum overall length	195.6 ± 2 mm (7.7 ± 0.08 inch)
Maximum overall width	215.4 ± 2 mm (8.48 ± 0.08 inch)
Maximum overall thickness	22.8± 2 mm (0.89± 0.08 inch)
Mass	670 g± 40g

F. Environmental relevant materials

Mercury (Hg)	Comply with RoHS Directive 2011/65/EU
Lead (Pb)	
Cadmium(Cd)	
Hexavalent Chromium(Cr6+)	
Polybrominated Biphenyls(PBBs)	
Polybrominated Diphenyl Ethers(PBDEs)	
Bis (2-ethylhexyl) phthalate(DEHP)	
Butyl benzyl phthalate(BBP)	
Dibutyl phthalate(DBP)	
Diisobutyl phthalate(DIBP)	

2. Outline Drawing

Unit : mm

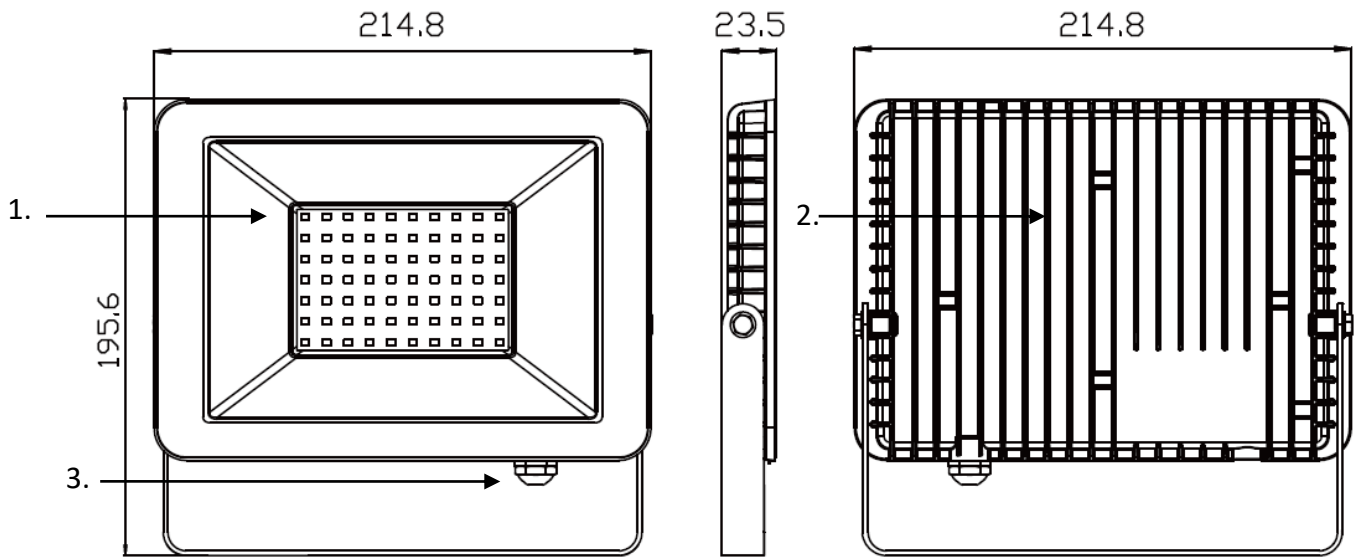

Material Information

- 1. Cover: Glass
- 2. Body: Metal
- 3. Gland: Metal

3. Light Distribution Curve

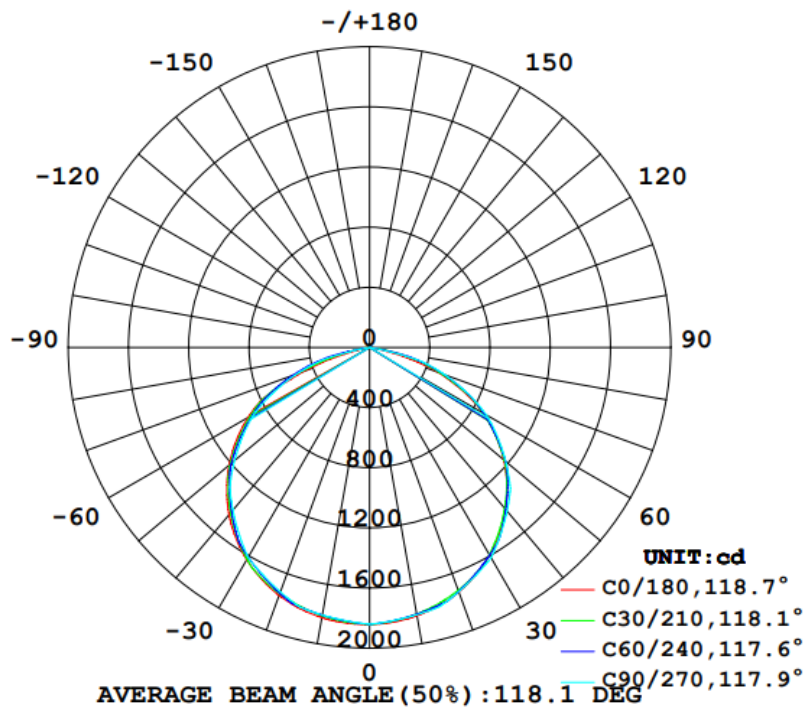

4. Spectrum Distribution

● 3000K Color Temperature

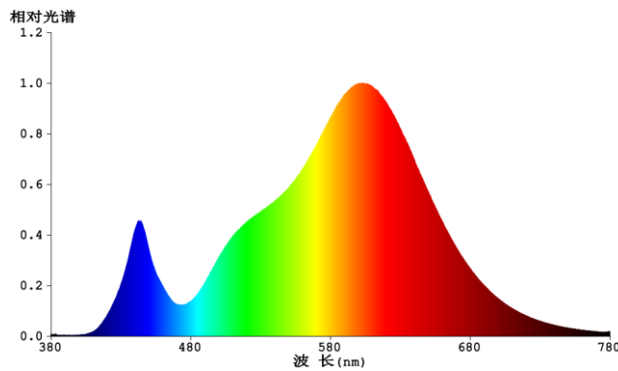

● 4000K Color Temperature

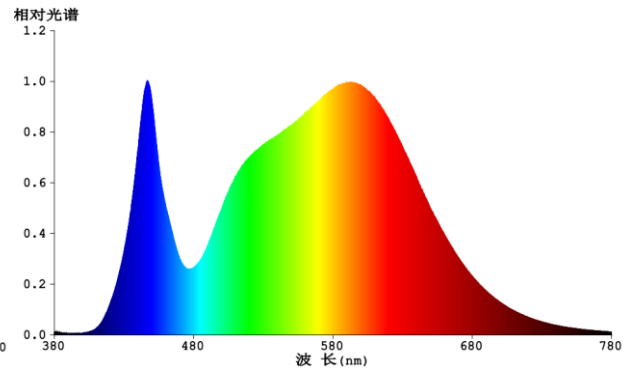

● 5000K Color Temperature

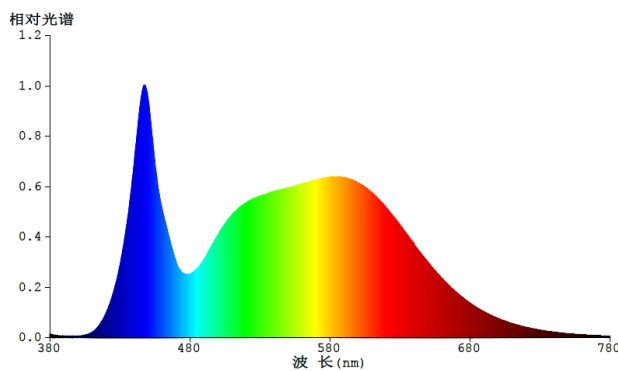

● 6500K Color Temperature

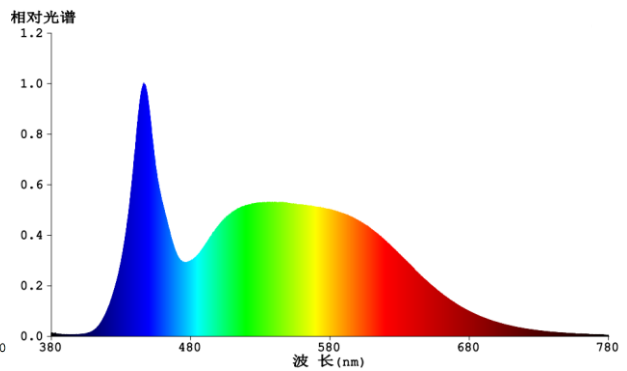

5. Warnings

- Before replacing, turn off power and let high bay cool to avoid electrical shock or burn.
- Do not touch electronic components, electronic components maybe under high voltage.
- Do not stare into LED light beam
- The luminaire shall be installed by a qualified electrician and wired in accordance with the latest IEE electrical regulations or the national requirements.

6. Cautions

Only to apply in dry and most of open fixtures with lamp-holders that offer sufficient space (10 mm free air space). Not intended for use with emergency light fixtures for exit lights.

7. Notes

All characteristics are estimated at room temperature (25°C), free air burning, base up burning position and at rated voltage. In view of the complex manufacturing process for light above for the technical LED parameters are merely statistical values that do not necessarily correspond to the actual technic individual products may vary from the typical values.

8. Logistic information

Model	LED Flood Light 50W 3000K	LED Flood Light 50W 4000K	LED Flood Light 50W 5000K	LED Flood Light 50W 6500K
Pieces per pack	1	1	1	1
EAN code on pack -Black shell	4711112386161	4711112384013	4711112385515	4711112386154
EAN code on pack -White shell	4711112388691	4711112388684	4711112388677	4711112388660
Size of pack	224x27x194mm	224x27x194mm	224x27x194mm	224x27x194mm
Weight per pack (G.W)	0.73kg	0.73kg	0.73kg	0.73kg
Packs per inner box	N/A	N/A	N/A	N/A
EAN code on inner box	N/A	N/A	N/A	N/A
ITF code on inner box	N/A	N/A	N/A	N/A
Size of inner box	N/A	N/A	N/A	N/A
Weight per inner box(G.W)	N/A	N/A	N/A	N/A
Packs per outer box	16	16	16	16
EAN code on outer box	N/A	N/A	N/A	N/A
ITF code on outer box -Black shell	14711112386168	14711112384010	14711112385512	14711112386151
ITF code on outer box -White shell	14711112388698	14711112388681	14711112388674	14711112388667
Size of outer box	245x238x408mm	245x238x408mm	245x238x408mm	245x238x408mm
Weight per outer box(G.W)	12.3Kg	12.3Kg	12.3Kg	12.3Kg

Package box

3000K



4000K



5000K



6500K



9. ERP Label

DELL-FL34050C5A011 / DELL-FL44050C5A011 / DELL-FL54050C5A011 / DELL-FLC4050C5A011

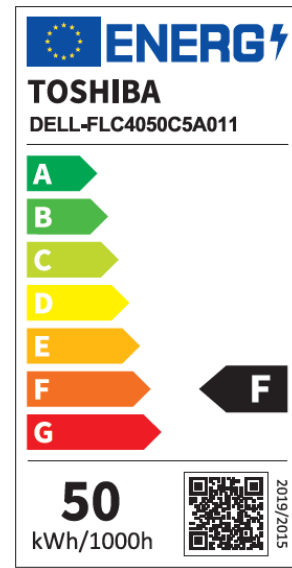
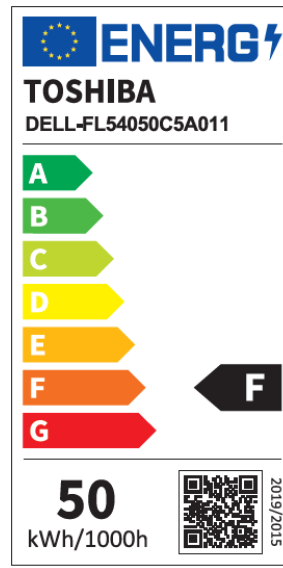
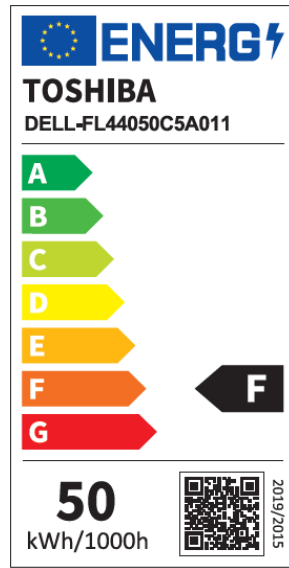
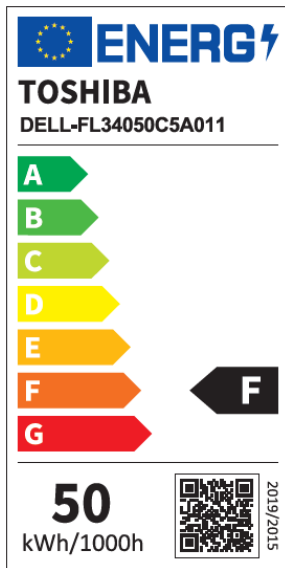

DELL-FL34050C5A021 / DELL-FL44050C5A021 / DELL-FL54050C5A021 / DELL-FLC4050C5A021

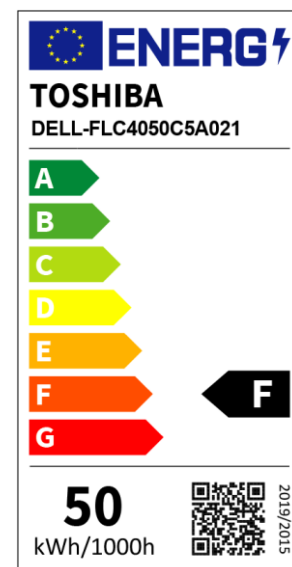
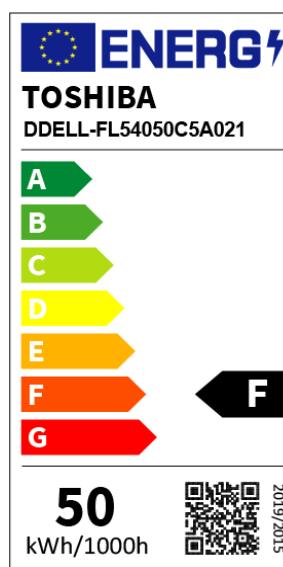
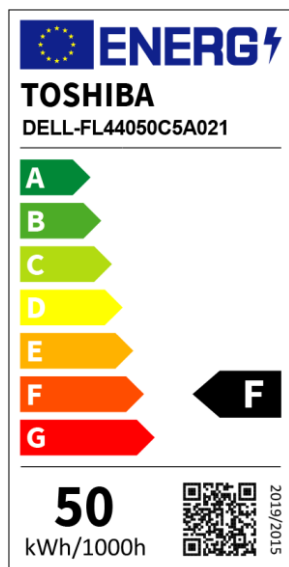
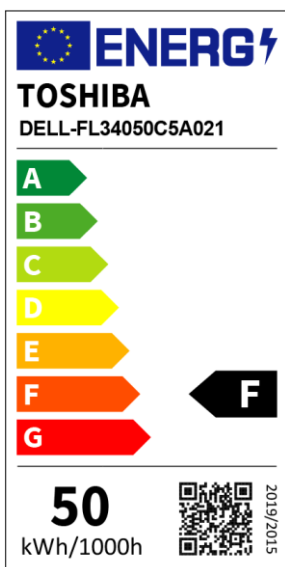

10. Conformity

2014/35/EU; Low Voltage Directive	EN 60598-2-5: 2015 ; EN IEC 60598-1: 2021 ; IEC/TR 62778:2014 ; EN 62493:2015 ; EN IEC 62031:2020
2014/30/EU; EMC Directive	EN IEC 55015: 2019+A11:2020 、 EN IEC 61000-3-2:2019+A1:2021 、 EN 61000-3-3: 2013+A2:2021 、 EN 61547: 2009
2009/125/EC; ErP Directive	(EU) 2019/2015 、 (EU) 2019/2020 、 (EU) 2021/340 、 (EU) 2021/341
2011/65/EU+(EU)2015/863; RoHS Directive	EN 50581: 2012