

# LED Dimmable SMD Candle- C35 5W E27

Authorized Licensee for TOSHIBA trademark



## 1. Specification:

### A. General Data

Model	C35 Dimmable 5W E27 2700K	C35 Dimmable 5W E27 3000K	C35 Dimmable 5W E27 4000K	C35 Dimmable 5W E27 6500K
P/N	DELS-CDW40052 7DE51	DELS-CD3400527 DE51	DELS-CD4400527 DE51	DELS-CDC40052 7DE51
Westnet Code	-	00172695	00172696	00172697
Rated Voltage	230 VAC			
Frequency	50/60 Hz			
Rated Wattage	5 W			
Deviation Tolerance of Wattage	±10 %			
Rated Current	0.023 A			
Maximum Input Current	0.026 A			
Start On	<0.5S			
Warm up time	<1S			
Dimmable	YES			
Beam Angle	240°			
Energy Efficiency Class(EEC)	F			
Peak luminous intensity(cd)	Non-directional			
R9 CRI	>0			
Survival factor	0.9			

<b>Safety requirements</b>	CE
<b>Displacement factor (cos φ1)**</b>	No limit
<b>Stroboscopic effect metric (SVM)</b>	0.4
<b>Flicker metric (PstLM)</b>	1
<b>Applicable Environments</b>	Dry locations; Not suitable for totally enclosed fixtures
<b>Ingress protection rating</b>	IP20
<b>Impact resistance</b>	N.A
<b>Incandescent Equivalent</b>	40W
<b>Base</b>	E27
<b>Photobiological Group</b>	RG 1

\* Displacement factor tolerance +/- 10%

\*\*No limit at  $P_{on} \leq 5W$

### B. Light Data

Color	Soft White	Warm White	Natural White	Cool White
<b>Color Temperature (CCT)</b>	2700K	3000K	4000K	6500K
<b>Lumen Output* (φTotal °)</b>	470 lm			
<b>Color Rendering Index*</b>	≥ 80			
<b>Efficacy(φTotal °)</b>	94 lm/W			
<b>Color Consistency**</b>	6 Step MacAdam Ellipse (6 SDCM)			

\* tolerance +/- 10%

\*\* 2700K center point (0.445766, 0.40983) · center point (0.4338, 0.403) · 4000K center point (0.3818, 0.3796) · 6500K center point (0.3123, 0.3283)

### C. Lifetime

(Supplied Voltage: AC 230V ; Ambient Temperature: 25°C)

<b>Lumen Maintenance Factor</b>	70% of the rated lifetime
<b>Rated Lifetime – L<sub>70</sub>B<sub>50</sub></b>	15,000 hrs
<b>Lumen Maintenance factor</b>	93.1%

#### D. Temperature Operation

Normal operation temperature	-20°C ~ 40°C
Relative Humidity	10% ~ 90%

#### E. Geometric Data

Model	C35 Dimmable 5W E27
Maximum overall length	35 ± 2 mm
Maximum overall width	105 ± 2 mm
Mass	20g ± 10%

#### F. Environmental relevant materials

Mercury (Hg)	Comply with RoHS Directive 2011/65/EU
Lead (Pb)	
Cadmium(Cd)	
Hexavalent Chromium(Cr6+)	
Polybrominated Biphenyls(PBBs)	
Polybrominated Diphenyl Ethers(PBDEs)	
Bis (2-ethylhexyl) phthalate(DEHP)	
Butyl benzyl phthalate(BBP)	
Dibutyl phthalate(DBP)	
Diisobutyl phthalate(DIBP)	

## 2. Outline Drawing

Unit : mm

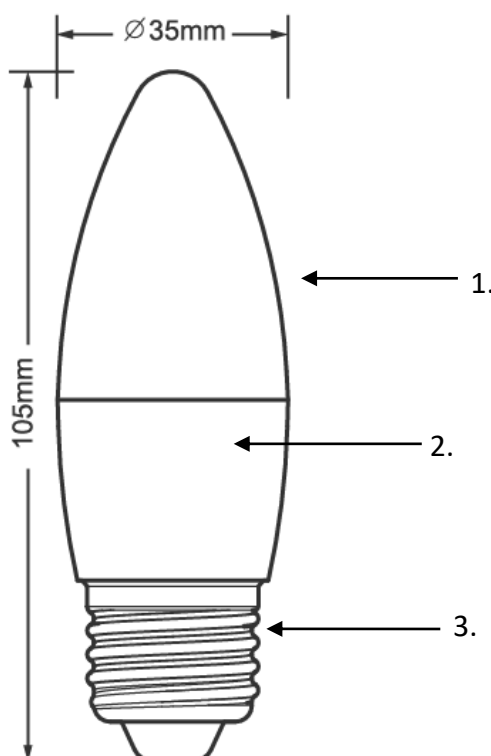

#### Material Information

1. Globe: Plastic
2. Body: Plastic
3. Base: Metal

### 3. Light Distribution Curve

FWHM 240°

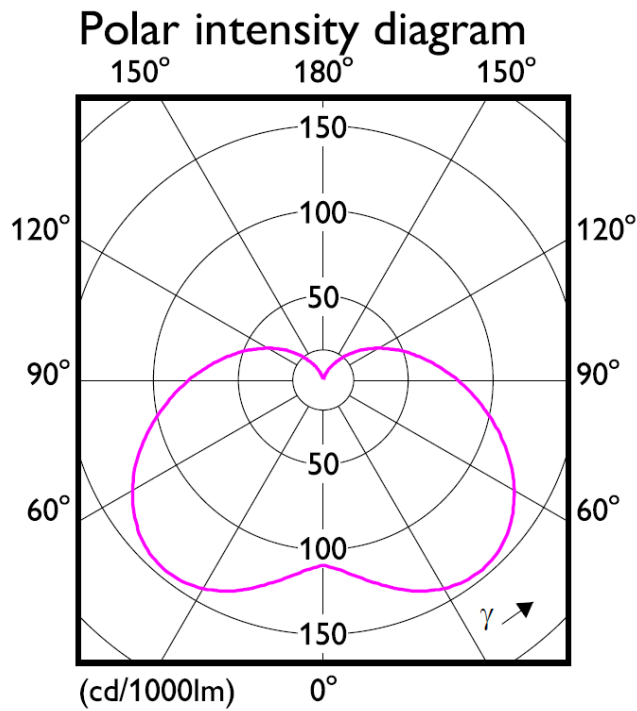

### 4. Spectrum Distribution

● 2700K Color Temperature

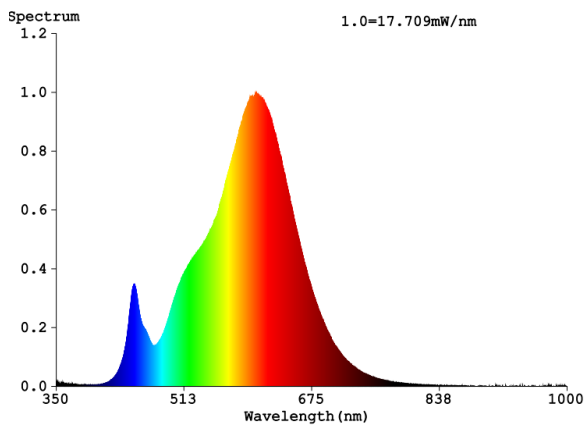

● 3000K Color Temperature

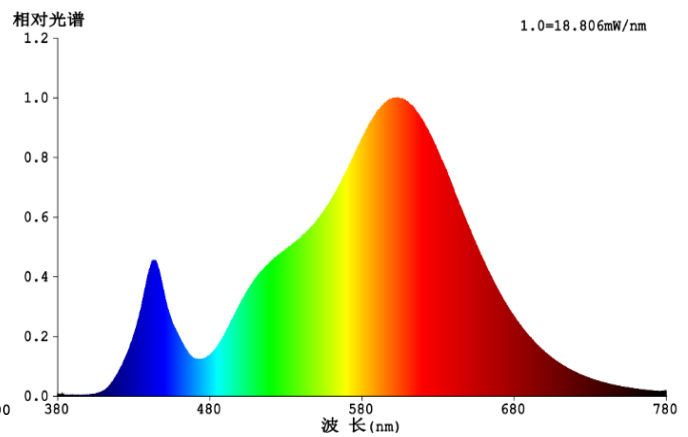

● 4000K Color Temperature

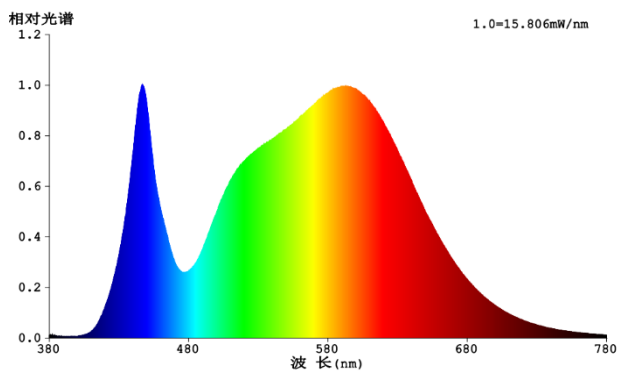

● 6500K Color Temperature

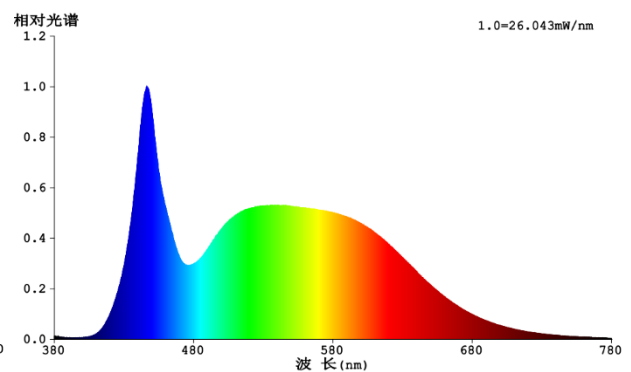

## 5. Warnings

Before replacing, turn off power and let lamp cool to avoid electrical shock or burn.

## 6. Cautions

Only to apply in dry and most of open fixtures with lamp-holders that offer sufficient space (10 mm free air space). Not intended for use with emergency light fixtures for exit lights.

## 7. Notes

All characteristics are estimated at room temperature (25°C), free air burning, base up burning position and at rated voltage. In view of the complex manufacturing process for light above for the technical LED parameters are merely statistical values that do not necessarily correspond to the actual technic individual products may vary from the typical values.

## 8. Logistic information

Model	C35 Dimmable 5W E27 2700K	C35 Dimmable 5W E27 3000K	C35 Dimmable 5W E27 4000K	C35 Dimmable 5W E27 6500K
Pieces per pack	1	1	1	1
EAN code on pack	4711112389742	4711112387380	4711112387397	4711112387403
Size of pack	37 * 37 * 115 mm			
Weight per pack (G.W)	30g			
Packs per inner box	N/A			
EAN code on inner box	N/A			
ITF code on inner box	N/A			
Size of inner box	N/A			
Weight per inner box(G.W)	N/A			
Packs per outer box	100			
EAN code on outer box	N/A			
ITF code on outer box	14711112389749	14711112387387	14711112387394	14711112387400
Size of outer box	390 * 200 * 250mm			
Weight per outer box(G.W)	2.8 kg			

Packing Photograph

DELS-CDW400527DE51 2700K

DELS-CD3400527DE51 3000K



DELS-CD4400527DE51 4000K

DELS-CDC400527DE51 6500K



## 9. ERP Label

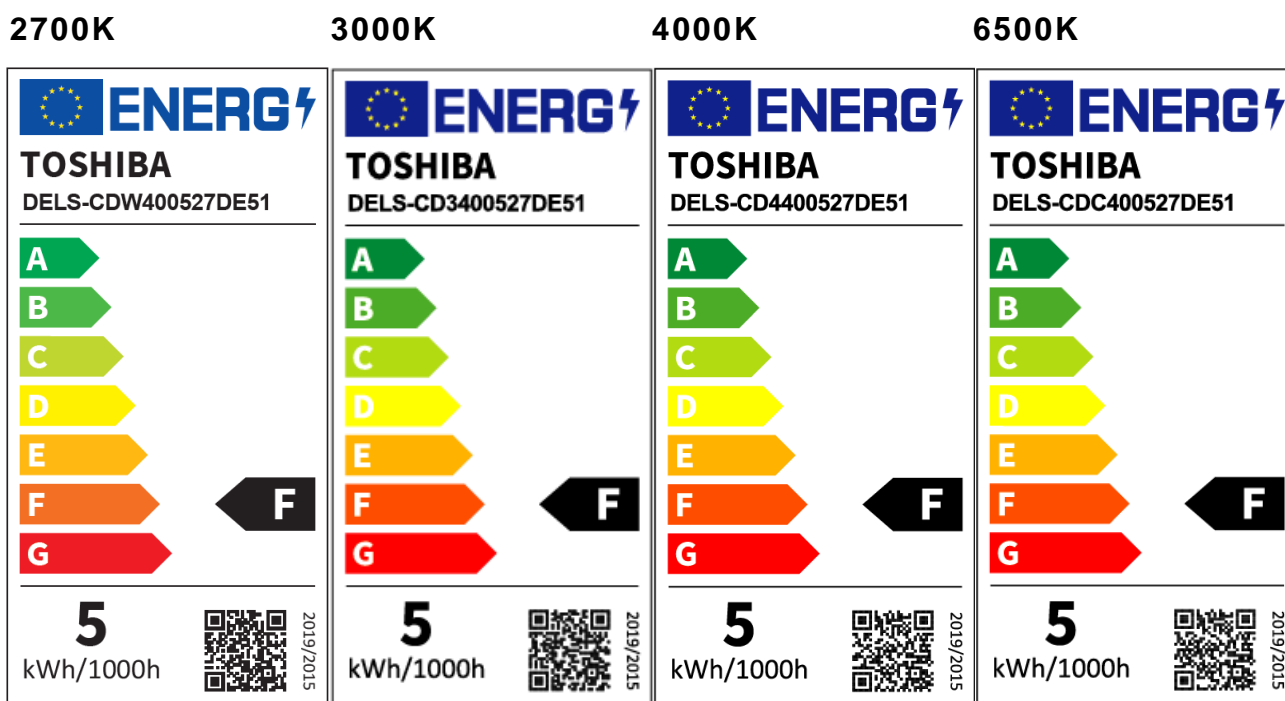

## 10. Conformity

2014/35/EU; Low Voltage Directive	EN 62560:2012 + A1:2015 + A11:2019 · EN 62493:2015 · IEC TR 62778:2014
2014/30/EU; EMC Directive	EN IEC 55015:2019 + A11:2020 · EN IEC 61000-3-2:2019+A1:20211 · EN 61547:2009 · EN 61000-3-3:2013 + A1:2019
2009/125/EC; ErP Directive	(EU) 2019/2015 · (EU) 2019/2020 · (EU)2021/340 · (EU)2021/341
2011/65/EU+(EU)2015/863; RoHS Directive	EN 50581: 2012