

**63A energy meter,
MID direct connection**

Cat. N°: 4 120 92 – 4 120 93



Contents	Pages
1. Use	1
2. Range	1
3. Installation	1
4. Dimensions	1
5. Connections	2
6. Operating data	2
7. General features	3
8. Conformity and certifications	6
9. Communication	7

1. USE

Bidirectional active and reactive energy meter (4 quadrants) with direct connection. The device, in 4 DIN modules, is self-powered and is equipped with ModBus communication or pulse output and double tariff input.

MID certification

2. RANGE

Code Art.	I _{max}	Output	Input	Range Voltage
4 120 92	63A	Pulse	Pulse	3x230V 3x400V ± 15%
4 120 93	63A	ModBus	2 Tariff	3x230V 3x400V ± 15%

3. INSTALLATION

Fixing:

On EN/IEC 60715 symmetric rail or DIN 35 rail.

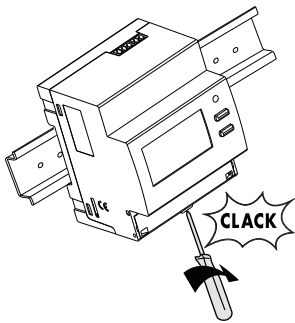

Necessary tools:

For fastening the device on the DIN rail: 5.5 mm flat screwdriver (from 4 to 6 mm).

Operating position:

Vertical, Horizontal, Upside down, On the side



4. DIMENSIONS

Housing: 4 DIN43880 modules

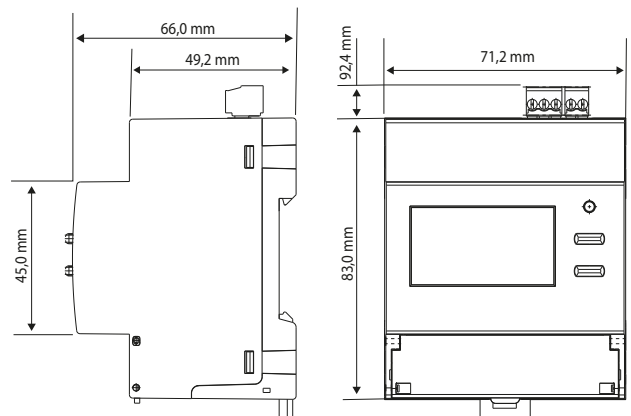

63A energy meter, MID direct connection

Cat. N°: 4 120 92 – 4 120 93

5. CONNECTIONS

Wiring diagrams:

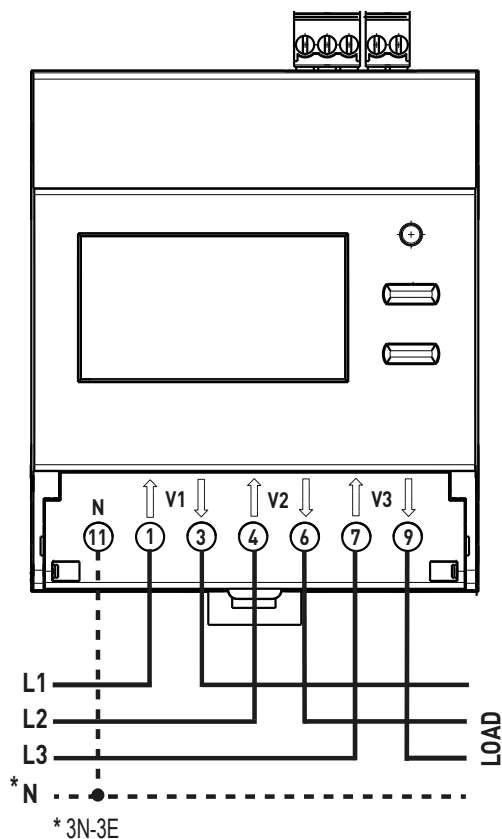

Terminal board marking and diagram combination:

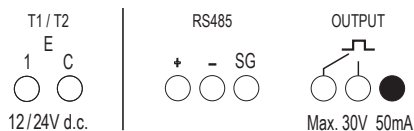

6. OPERATING DATA

6.1 ELECTRIC DATA

Currents:

- Reference current, I_{ref} : 5A
- Minimum current, I_{min} : 0,25A
- Maximum current, I_{max} : 63A
- Starting current, I_{st} : 20mA

Rated voltages:

- Three-phase rated voltage U_n : 3x230V~ / 3x400V~ $\pm 15\%$

Rated frequency:

- F_n : 50Hz; 60Hz
- Permitted variation: 49...51Hz; 59...61Hz

Connectable section:

- Copper wires
- Voltage connection terminals (V1, V2, V3, N):

	Without bush	With bush
Rigid wire	1 x 0,75 + 16 mm ²	-
Flexible wire	1 x 0,75 + 16 mm ² (\varnothing 5mm)	1 x 4 + 10 mm ²

- Terminal boards in the upper part of the meter (input, impulse output):

	Without bush	With bush
Rigid wire	1 x 0,2 + 1,5 mm ²	-
Flexible wire	1 x 0,2 + 1 mm ²	1 x 0,2 + 1 mm ²

Necessary tools:

- For the voltage connection terminals (V1, V2, V3): screwdriver with 6mm blade or Pozidriv No. 2
- For the Neutral (N) connection terminal: screwdriver with 6mm blade or Pozidriv No. 2
- For the terminal boards in the upper part of the meter (input, impulse output): screws with 2.5mm blade

63A energy meter, MID direct connection

Cat. N°: 4 120 92 – 4 120 93

6.2 MECHANICAL DATA

Screw terminals:

- Depth of the terminals: 12mm
- Lengths of the wire stripping: 11mm

Screw head:

- Voltage connection terminals (V1, V2, V3): screws with countersunk head with hexagon socket and Pozidriv No. 2
- Neutral (N) connection terminal: screw/screws with countersunk head with hexagon socket and Pozidriv No. 2
- Terminal boards in the upper part of the meter (input, impulse output): screws with countersunk head with hexagon socket

Recommended torque:

- Voltage connection terminals (V1,V2,V3): from 1,6 to 2Nm
- Neutral (N) connection terminal: from 1,6 to 2Nm
- Terminal boards in the upper part of the meter (input, impulse output): 0.2 N/m

Terminal protection:

- The power terminals are protected with sliding and sealable terminal front covers which are integrated in the device

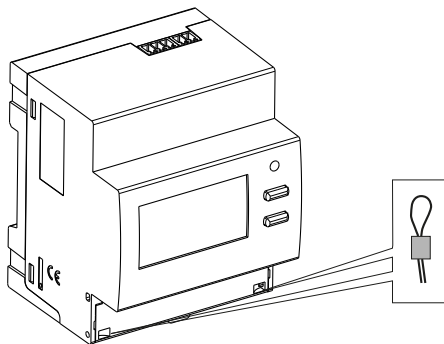

7. GENERAL FEATURES (continues)

Marking data:

Indelible marking

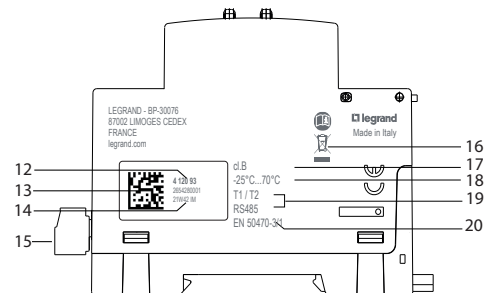
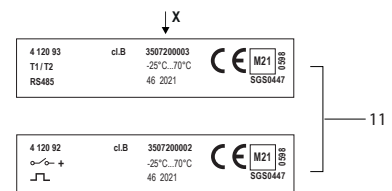
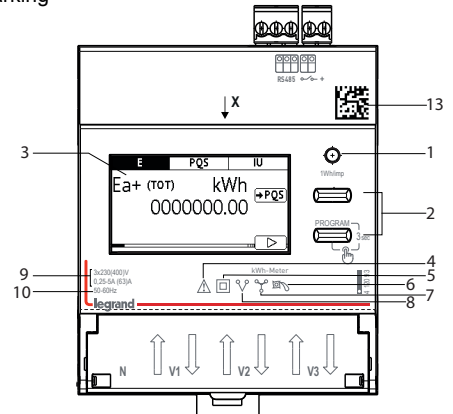

1. Metrological LED
2. Keypad made up of 2 double-function pushbuttons (display/configurations)
3. Graphic display
4. Consult the user manual before installation
5. Double insulation
6. Anti-rotation device (anti-decreasing)
7. Connection on 4-wire three-phase line
8. Connection on 3-wire three-phase line
9. Voltage/Current
10. Frequency
11. MID label
12. Product code
13. Datamatrix for product traceability
14. Week and year of manufacture
15. Output connection terminals
16. RAEE Symbol
17. Precision class
18. Temperature of use
19. Outputs
20. MID standard

7. GENERAL FEATURES

Laser marking

Left side
Traceability information

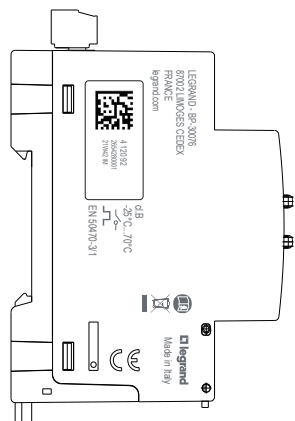
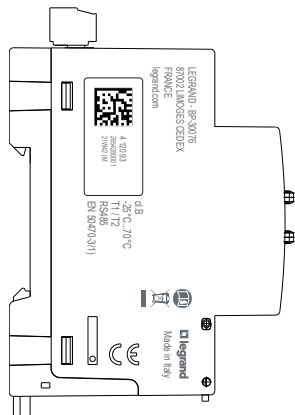

Right side
Wiring diagram

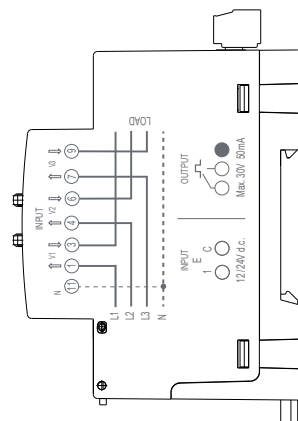
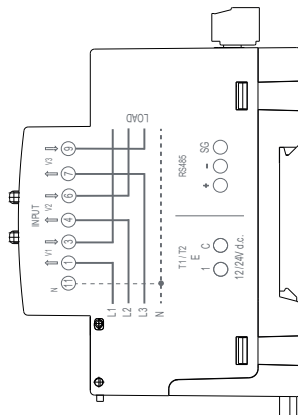

7. GENERAL FEATURES (continues)

Display:

- Graphic, backlit, 1.8 inches (256x128).

Resolution:

- Total meters: 0,01kWh/kvarh
- Partial meters: 0,01kWh/kvarh
- Tariff meters: 0,01kWh/kvarh

Maximum indication

- Total meters: 9 999 999,99
- Partial meters: 9 999 999,99
- Tariff meters: 9 999 999,99

Metrological LED: 1Wh/imp.

Display of the value and programming:

- By means of the front keypad, 2 pushbuttons.
- Change protected by identification code (**predefined code 1000**); the code can be changed during the programming procedure.

Measurements and precision in conformity with EN/IEC 61557-12

- Current: cl.0,5
- Voltage: cl.0,5
- Frequency: $\pm 0,1$ Hz
- Instantaneous total active power, phase, average value and max. average value cl.1
- Instantaneous total active power, phase, average value and max. average value: cl.1
- Instantaneous total reactive power, phase: cl.2
- Instantaneous total apparent power, phase: cl.1
- Power Factor: cl.1

Average power:

- Measurement: active power
- Calculation: moving average, on the selected period
- Average time: 5/8/10/15/20/30/60 min.

Hour meter:

- Counting of operating hours and minutes (**resettable meter**)
- Resolution: 7 figures (5 for the hours + 2 for the minutes)
- Maximum display: 99 999.59 (tariff total)
- Programmable value: 0...50% Pn (positive)

7. GENERAL FEATURES

Digital input

- The digital input allows switching the energy counting on 2 tariffs
- 2 input terminals with common point (1 - C)
- Rated voltage: 12 – 24V d.c. max. 10mA

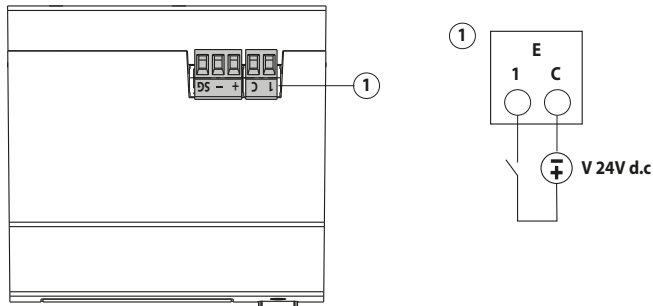

Features of the ModBus communication port:

- Programmable addresses: from 1 to 255 (5*)
- Communication speed: 4.8 – 9.6 – 19.2* – 38.4 kbps
- No. of bit: 8
- Parity bit: none, even*, odd
- Stop bit: 1
- Galvanically isolated with respect to the measurement inputs
- Standard RS485 3 wires, half-duplex
- Modbus® RTU protocol
- Response time (question/response time-out): ≤ 200ms
- 120Ω terminating resistor inside the instrument
(it can be set in the SETUP menu, default value: none*)

Features of the Impulse output:

- Optorelay with potential-free SPST-NO contact
- Type S0 (IEC/EN62053-31)
- Voltage U_{imp}: Max. 24V a.c./d.c.
- Current I_{imp}: Max. 50 mA
- Programmable impulse weight, possible values:
1 – 10* – 100 – 1k – 10k Wh/imp or varh/imp
- Programmable impulse duration, possible values:
50 -100* – 200 – 300 – 400 – 500ms

* Factory setting

7. GENERAL FEATURES

Auxiliary power supply:

- Shunted from the power socket (Self-supplied)

Operating room temperatures:

- Min. = - 25 °C Max. = + 70 °C

Room storage temperatures:

- Min. = - 25 °C Max. = + 70 °C
- Max.humidity. 85% non-condensing

Short-duration overcurrent:

- 30 I_{max} per 10ms

Short circuit current:

- I_{max} (kA): 17,5 (Δt: 7,4msec)
- Energy 0.635 MA²s

Voltage circuit self-consumption:

- Max.1,5VA three-phase

Current circuit self-consumption:

- Max.1,8W for each phase

Maximum dissipated thermal power for the thermal dimensioning of the panels: ≤ 6W

Protection class:

- Terminal protection index against solid bodies and liquids:
IP 20 (IEC/EN 60529).
- Housing protection index against solid bodies and liquids:
IP 54 (IEC/EN 60529).

Protection of the device:

- By means of thermal-magnetic circuit breaker

Room: mechanical M1 – electric E2 (according to the directive MID 2014/32/UE)

Housing material: Polycarbonate

Packaged volume: 0,60 dm³

Wheight: 0,210Kg

MID direct connection

8. CONFORMITY AND CERTIFICATIONS

Insulation

- Measurement categories: III
- Level of pollution: 2
- Insulation voltage, U_i : 300V, Phase-Neutral

Dielectric rigidity:

- Power supplies/ Outputs: 4kV / 50Hz / 1min
- Housing / Terminals: 4kV / 50Hz / 1min

Pulse:

- Power supplies: 6.3kV / 1.2 – 50 μ sec / 0.5J
- Power supplies/ Outputs: 6.3kV / 1.2- 50 μ s / 0.5J

In compliance with the standards:

- Precision class: Class B active energy (EN 50470-1, -3)
- Precision class: Class 2 reactive energy (EN/IEC 62053-23)
- Electromagnetic compatibility: Tests in accordance with EN 50470-1, -3
- Precision class according to IEC/EN61557-12

Respecting the environment – Conformity with the CEE directives:

- Conformity with directive 2011/65/EU modified by directive 2015/863 (RoHS 2) which restricts hazardous substances such as lead, mercury, cadmium, hexavalent chromium, brominated flame retardants, polybrominated biphenyls (PBB) and polybrominated diphenyl ethers (PBDE)
- Conformity with directive 91/338/CEE of 18/06/91 and decree 94-647 of 27/07/04
- Conformity with the REACH regulation

Plastic materials:

- Plastic materials without Halogens.
- Part marking according to standards ISO 11469 and ISO 1043.

Packaging:

- Packaging designed and produced in accordance with Decree 98-638 of 07.20.98 and directive 94/62/CE

9. COMMUNICATION

RS485 Modbus wiring diagram:

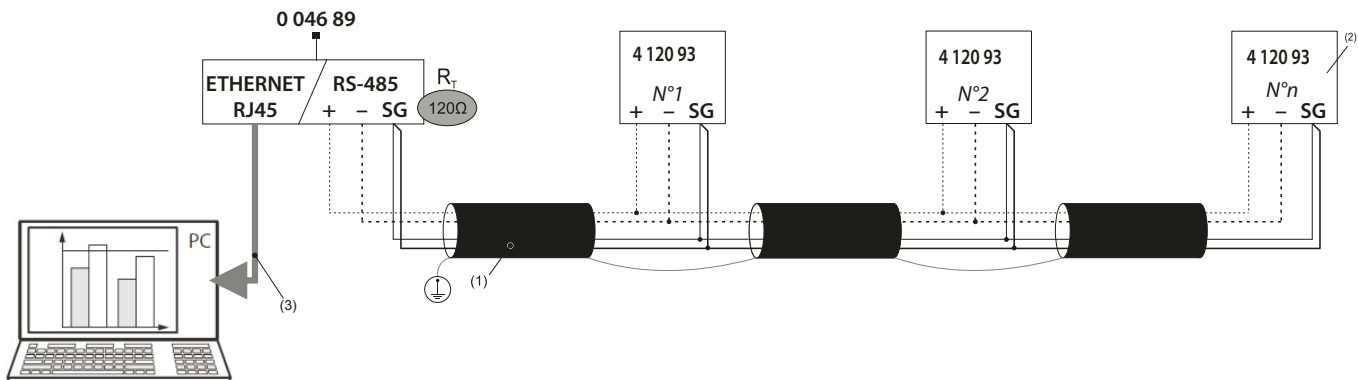

RS485 Modbus wiring diagram with Mini Web Server:

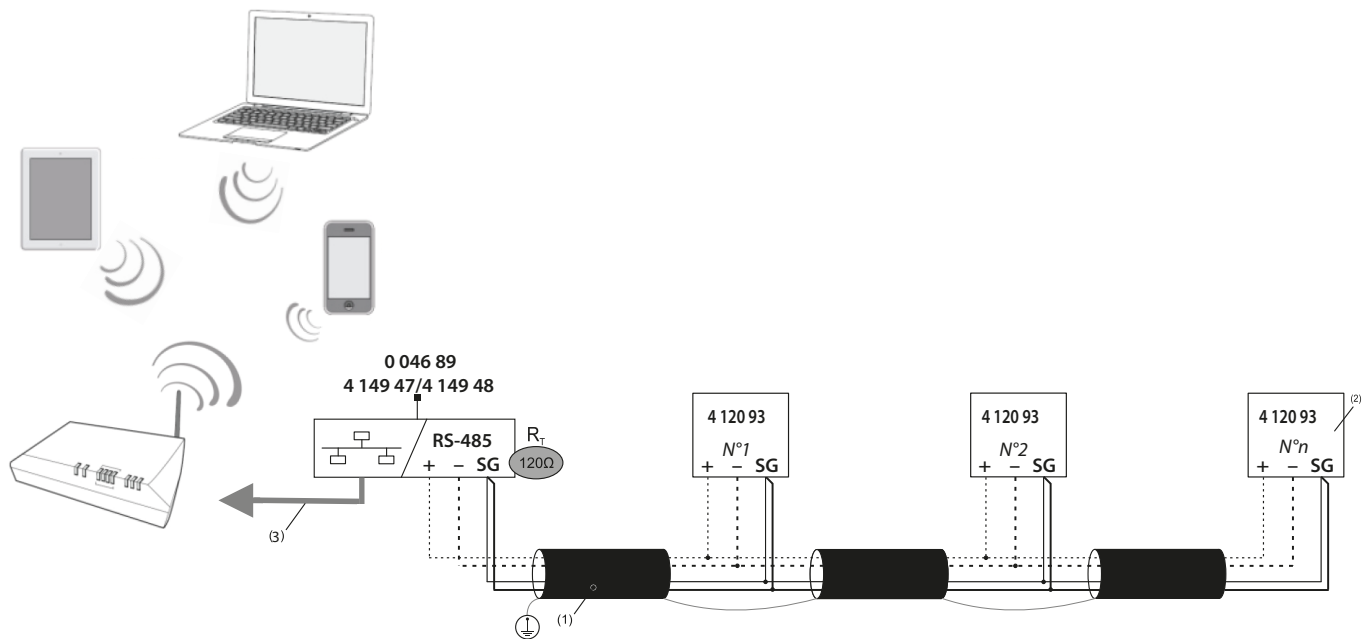

(1) RS485: Required use of Belden 9842 or Belden 3106A wire (or equivalent) for a maximum bus length of 1000 m, or Category 6 wire (FTP or UTP) for a maximum length of 50 m

(2) 120Ω terminating resistor inside the instrument (it can be set in the SETUP menu)

(3) Ethernet: Cat. 6 (FTP/UTP)

Communication tables

- Modbus communication tables are available at www.e-catalogue.legrandgroup.com