

**63A single-phase energy meter,
MID direct connection**

Cat. N°: 4 120 82 – 4 120 83



Contents	Pages
1. Use	1
2. Range	1
3. Installation	1
4. Dimensions	1
5. Connections	2
6. Operating data	2
7. General features	3
8. Conformity and certifications	6
9. Communication	7

1. USE

Bidirectional active and reactive energy meter (4 quadrants) with direct connection.
The device, in 2 DIN modules, is self-powered and is equipped with ModBus communication or pulse output and double tariff input.

MID certification

2. RANGE

Code Art.	I _{max}	Output	Input	Range Voltage
4 120 82	63A	Pulse	Pulse	230V ± 15%
4 120 83	63A	ModBus	2 Tariff	230V ± 15%

3. INSTALLATION

Fixing:

On EN/IEC 60715 symmetric rail or DIN 35 rail.

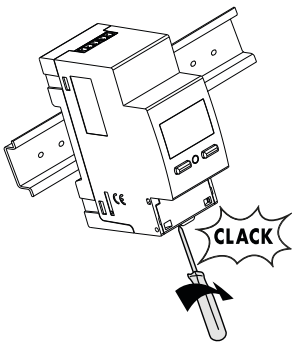

Necessary tools:

For fastening the device on the DIN rail: 5.5 mm flat screwdriver (from 4 to 6 mm).

Operating position:

Vertical, Horizontal, Upside down, On the side



4. DIMENSIONS

Housing: 2 DIN43880 modules

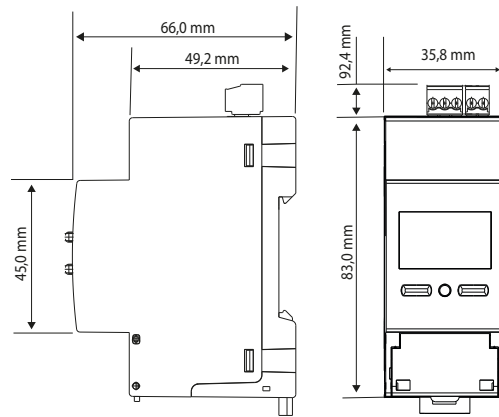

**63A single-phase energy meter,
MID direct connection**

Cat. N°: 4 120 82 – 4 120 83

5. CONNECTIONS

Wiring diagrams:

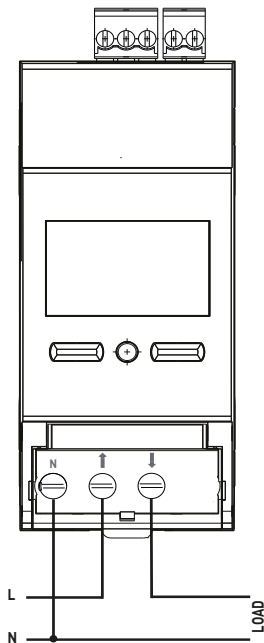

Terminal board marking and diagram combination:

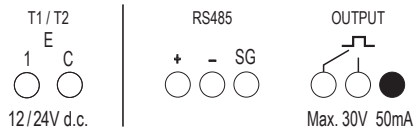

6. OPERATING DATA

6.1 ELECTRIC DATA

Currents:

- Reference current, I_{ref} : 10A
- Minimum current, I_{min} : 0,5A
- Maximum current, I_{max} : 63A
- Starting current, I_{st} : 0,04A

Rated voltages:

- Single-phase rated voltage U_n : 230V \pm 15%

Rated frequency:

- F_n : 50Hz; 60Hz
- Permitted variation: 49...51Hz; 59...61Hz

Connectable section:

- Copper wires
- Voltage connection terminals, neutral:

	Without bush	With bush
Rigid wire	1 x 0,75 + 16 mm²	-
Flexible wire	1 x 0,75 + 16 mm² (\varnothing 5mm)	1 x 4 + 10 mm²

- Terminal boards in the upper part of the meter (input, impulse output):

	Without bush	With bush
Rigid wire	1 x 0,2 + 1,5 mm²	-
Flexible wire	1 x 0,2 + 1 mm²	1 x 0,2 + 1 mm²

Necessary tools:

- For the voltage connection terminals, neutral: screwdriver with 6mm blade or Pozidriv No. 2
- For the terminal boards in the upper part of the meter (input, impulse output): screws with 2.5mm blade

63A single-phase energy meter, MID direct connection

Cat. N°: 4 120 82 – 4 120 83

6.2 MECHANICAL DATA

Screw terminals:

- Depth of the terminals: 12mm
- Lengths of the wire stripping: 11mm

Screw head:

- Voltage connection terminals, neutral: screws with countersunk head with hexagon socket and Pozidriv No. 2
- Terminal boards in the upper part of the meter (input, impulse output): screws with countersunk head with hexagon socket

Recommended torque:

- Voltage connection terminals, neutral: from 1,6Nm to 2Nm
- Terminal boards in the upper part of the meter (input, impulse output): 0.2 N/m

Maximum torque:

- Voltage connection terminals, neutral: 3 Nm
- Terminal boards in the upper part of the meter (input, impulse output): 0.3 Nm

Terminal protection:

- The power terminals are protected with sliding and sealable terminal front covers which are integrated in the device

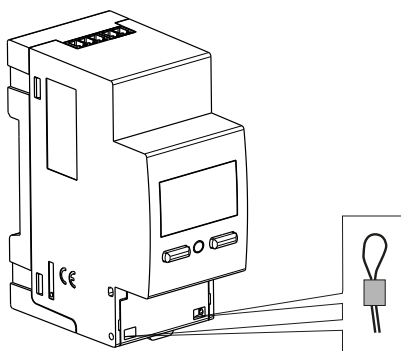

7. GENERAL FEATURES (continues)

Marking data:

Indelible marking

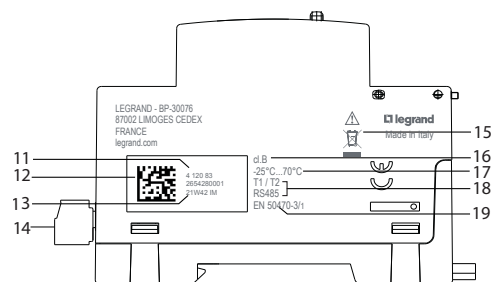
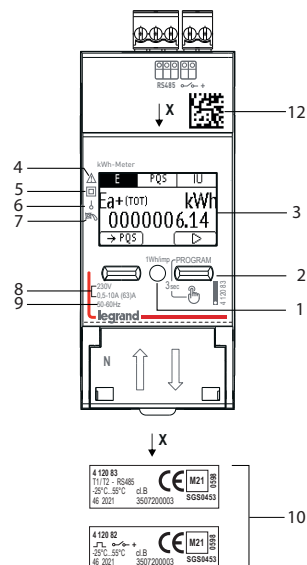

1. Metrological LED
2. Keypad made up of 2 double-function pushbuttons (display/configurations)
3. Graphic display
4. Consult the user manual before installation
5. Double insulation
6. Connection on single-phase line
7. Anti-rotation device (anti-decreasing)
8. Voltage / Current
9. Frequency
10. MID label
11. Product code
12. Datamatrix for product traceability
13. Week and year of manufacture
14. Output connection terminals
15. RAEE Symbol
16. Precision class
17. Temperature of use
18. Outputs
19. MID standard

MID direct connection

7. GENERAL FEATURES

Laser marking

Left side

Traceability information

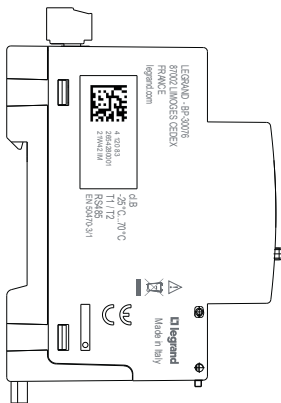

Right side

Wiring diagram

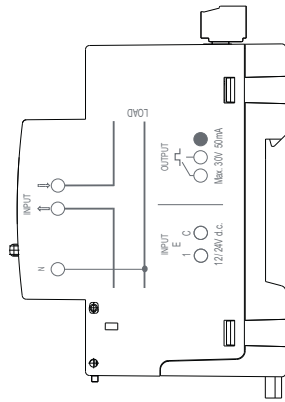
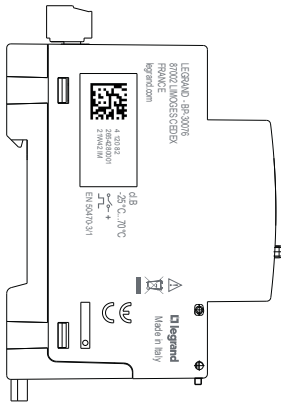
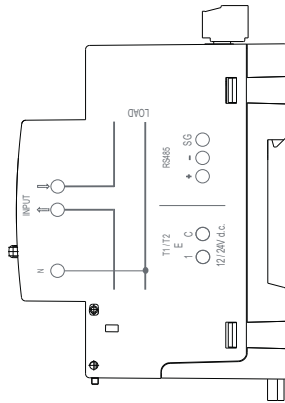

7. GENERAL FEATURES (continues)

Display:

- Graphic, backlit, 1.2 inches (128x64).

Resolution:

- Total meters: 0,01kWh/kvarh
- Partial meters: 0,01kWh/kvarh
- Tariff meters: 0,01kWh/kvarh

Maximum indication

- Total meters: 9 999 999,99
- Partial meters: 9 999 999,99
- Tariff meters: 9 999 999,99

Metrological LED: 1Wh/imp.

Display of the value and programming:

- By means of the front keypad, 2 pushbuttons.
- Change protected by identification code (**predefined code 1000**); the code can be changed during the programming procedure.

Measurements and precision in conformity with EN/IEC 61557-12

- Current: cl.0,5
- Voltage: cl.0,5
- Frequency: $\pm 0,01\text{Hz}$
- Instantaneous total active power, phase, average value and max. average value cl.1
- Instantaneous total reactive power, phase: cl.2
- Instantaneous total apparent power, phase: cl.1
- Power Factor: cl.1

Average power:

- Measurement: active power
- Calculation: moving average, on the selected period
- Average time: 5/8/10/15/20/30/60 min.

Hour meter:

- Counting of operating hours and minutes (**resettable meter**)
- Resolution: 7 figures (5 for the hours + 2 for the minutes)
- Maximum display: 99 999.59 (tariff total)
- Programmable value: 0...50% Pn (positive)

MID direct connection

7. GENERAL FEATURES

Digital input

- The digital input allows switching the energy counting on 2 tariffs
- 2 input terminals with common point (1 - C)
- Rated voltage: 12 – 24V d.c. max. 10mA

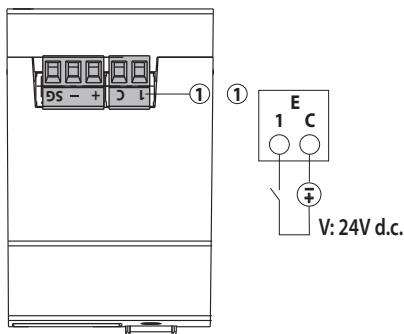

Features of the ModBus communication port:

- Programmable addresses: from 1 to 255 (5*)
- Communication speed: 4.8 – 9.6 – 19.2* – 38.4 kbps
- No. of bit: 8
- Parity bit: none, even*, odd
- Stop bit: 1
- Galvanically isolated with respect to the measurement inputs
- Standard RS485 3 wires, half-duplex
- Modbus® RTU protocol
- Response time (question/response time-out): ≤ 200ms
- 120Ω terminating resistor inside the instrument
(it can be set in the SETUP menu, default value: none*)

Features of the Impulse output:

- Optorelay with potential-free SPST-NO contact
- Type S0 (IEC/EN62053-31)
- Voltage Uimp: Max. 24V a.c./d.c.
- Current Iimp: Max. 50 mA
- Programmable impulse weight, possible values:
1 – 10* – 100 – 1k – 10k Wh/imp or varh/imp
- Programmable impulse duration, possible values:
50 - 100* – 200 – 300 – 400 – 500ms

* Factory setting

7. GENERAL FEATURES

Auxiliary power supply:

- Shunted from the power socket (Self-supplied)

Operating room temperatures:

- Min. = - 25 °C Max. = + 70 °C

Room storage temperatures:

- Min. = - 25 °C Max. = + 70 °C
- Max.humidity. 85% non-condensing

Short-duration overcurrent:

- 30 I_{max} per 10ms

Short circuit current:

- I_{max} (kA): 17,5 (Δt: 7,4msec)
- Energy 0.635 MA²s

Voltage circuit self-consumption:

- Max.1,5VA

Current circuit self-consumption:

- Max.1,8W

Maximum dissipated thermal power for the thermal dimensioning of the panels: ≤ 4W

Protection class:

- Terminal protection index against solid bodies and liquids: IP 20 (IEC/EN 60529).
- Housing protection index against solid bodies and liquids: IP 54 (IEC/EN 60529).

Protection of the device:

- By means of thermal-magnetic circuit breaker

Room: mechanical M1 – electric E2 (according to the directive MID 2014/32/UE)

Housing material: Polycarbonate

Packaged volume: 0,192 dm³

Wheight: 0,130Kg

MID direct connection

8. CONFORMITY AND CERTIFICATIONS

Insulation

- Measurement categories: III
- Level of pollution: 2
- Insulation voltage, U_i : 300V, Phase-Neutral

Dielectric rigidity:

- Power supplies/ Outputs: 4kV / 50Hz / 1min
- Housing / Terminals: 4kV / 50Hz / 1min

Pulse:

- Power supplies: 6.3kV / 1.2 – 50 μ sec / 0.5J
- Power supplies/ Outputs: 6.3kV / 1.2- 50 μ s / 0.5J

In compliance with the standards:

- Precision class: Class B active energy (EN 50470-1, -3)
- Precision class: Class 2 reactive energy (EN/IEC 62053-23)
- Electromagnetic compatibility: Tests in accordance with EN 50470-1, -3
- Precision class according to IEC/EN61557-12

Respecting the environment – Conformity with the CEE directives:

- Compliance with the 2100/65/EU Directive, as modified by the 2015/863 Directive (RoHS 2), on the restriction of the use of certain hazardous substances in electrical and electronic equipment.
- Conformity with the REACH Regulation (1907/ 2006): at the date of publication of this document no substance in the annex XIV is found in these products.
- RAEE Directive (2012/19/EU: the sale of this product includes a contribution to the appointed environmental bodies of each European country in charge of handling, at the end of their life, the products falling within the scope of the EU Directive on Electric and Electronic Equipment Waste.

Plastic materials:

- Plastic materials without Halogens.
- Part marking according to standards ISO 11469 and ISO 1043.

Packaging:

- Packaging designed and produced in accordance with Decree 98-638 of 07.20.98 and directive 94/62/CE

9. COMMUNICATION

RS485 Modbus wiring diagram:

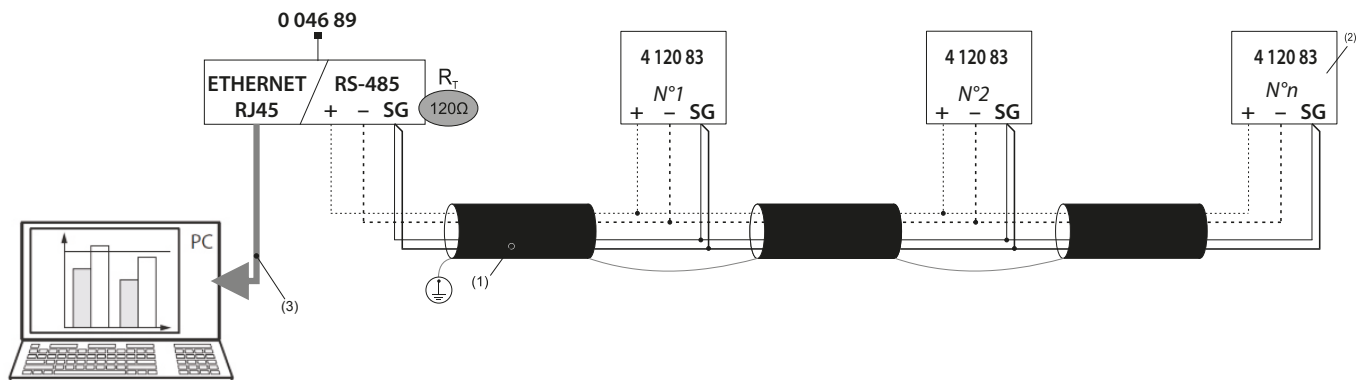

RS485 Modbus wiring diagram with Mini Web Server:

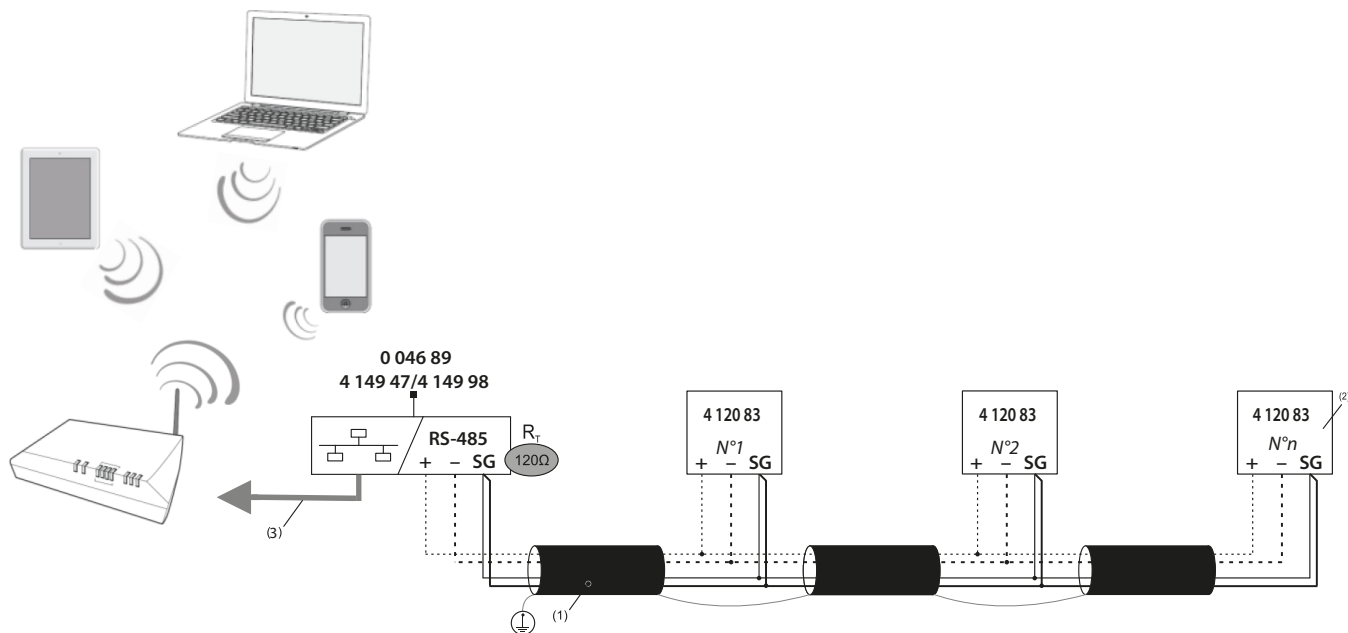

(1) RS485: Required use of Belden 9842 or Belden 3106A wire (or equivalent) for a maximum bus length of 1000 m, or Category 6 wire (FTP or UTP) for a maximum length of 50 m

(2) 120Ω terminating resistor inside the instrument (it can be set in the SETUP menu)

(3) Ethernet: Cat. 6 (FTP/UTP)

Communication tables

. Modbus communication tables are available at www.e-catalogue.legrandgroup.com