

# Incara™ Disq'In

Cat. No(s): 6 547 40 to 51 - 6 547 55 to 57 - 6 547 59 to 61 - 6 547 63 to 65

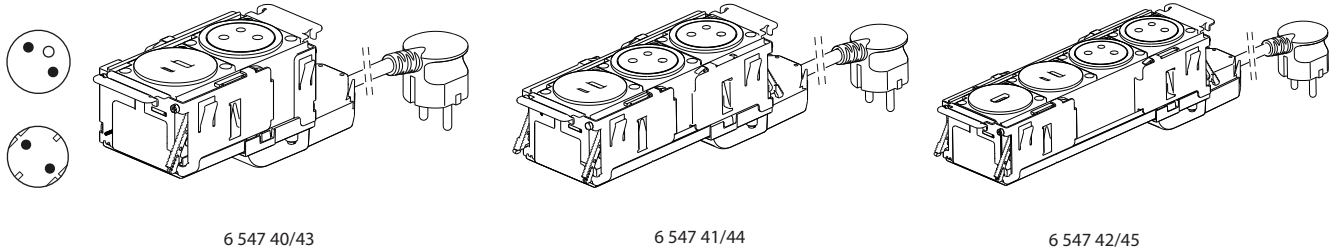

6 547 40/43

6 547 41/44

6 547 42/45

## 1. USE

Incara™ Disq'In is an aesthetic integrated solution for individual desks and meeting rooms tables. The range is available in 2, 3 and 4 gang and provides essential functions for workstation. Provided with fast fixing claws system, Incara™ Disq'In is easy and fast to install. For a perfect finish, metal plates are available in white, black or brushed metal.

## 2. RANGE

Incara™ Disq'In 2 m cord equipped with :			Standards	2 gang		3 gang		4 gang	
				White	Black	White	Black	White	Black
1x 2P+E	1 USB A+C	-	French	6 547 40	6 547 43	-	-	-	-
2x 2P+E		-		-	6 547 41	6 547 44	-	-	
		1 HDMI	-	-	-	-	6 547 42	6 547 45	
1x 2P+E		-	Schuko	6 547 46	6 547 49	-	-	-	-
	-	-		-	6 547 47	6 547 50	-	-	
2x 2P+E	1 HDMI	-		-	-	-	6 547 48	6 547 51	

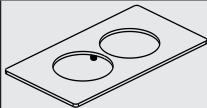
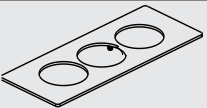
Metal finishes plates*	2 gang	3 gang	4 gang
			
Metal	6 547 55	6 547 59	6 547 63
White	6 547 56	6 547 60	6 547 64
Black	6 547 57	6 547 61	6 547 65

\* Finishes (4 additional colors available on demand)

HDMI = coupler (female/female)

Other wiring devices configurations possible on demand

British Standard products available on request

**3. DIMENSIONS**

■ **3.1 Finishes plates Incara™ Disq'In**

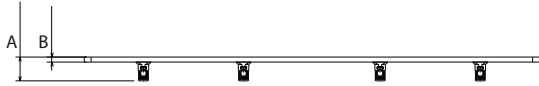

Cat. Nos	A	B
6 547 55/56/57	10.4	2.2
6 547 59/60/61		
6 547 63/64/65		

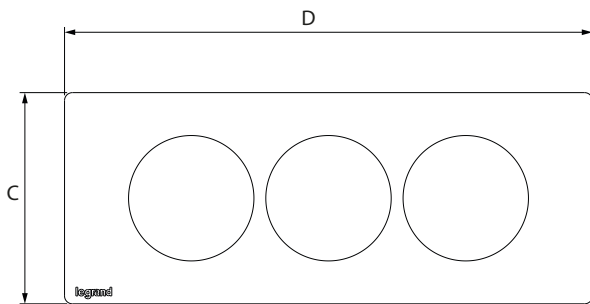

Cat. Nos	C	D
6 547 55/56/57	80	148
6 547 59/60/61		200
6 547 63/64/65		252

**3. DIMENSIONS (cont.)**

■ **3.2 2G-3G-4G Incara™ Disq'In: Top view**

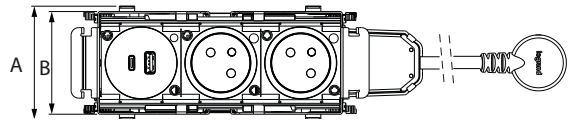

Cat. Nos	A	B
6 547 40/41/42/43/44/45/46 /47/48/49/50/51	74	67

■ **3.3 Incara™ Disq'In: Side view**

**2 gang**

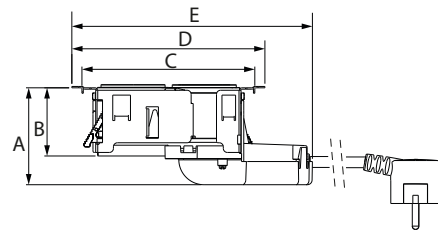

Cat. Nos	A	B	C	D	E
6 547 40/43/46/49	71	50	126.8	141.6	176.4

**3 gang**

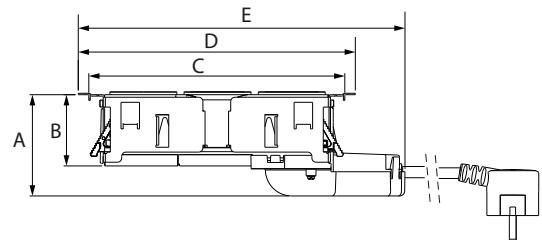

Cat. Nos	A	B	C	D	E
6 547 41/44/47/50	71	50	179.7	194.5	229.4

**4 gang**

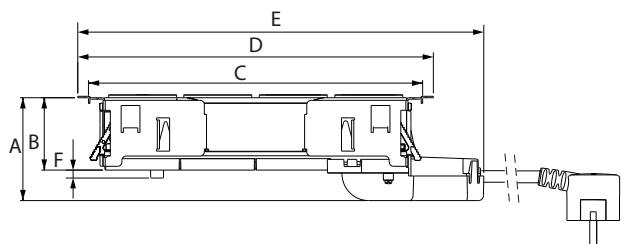

Cat. Nos	A	B	C	D	E	F
6 547 42/45/48/51	71	50	231	245.8	280.6	5.5

#### 4. INSTALLATION

Must not be fitted on the floor

##### ■ 4.1 Into the desk

##### 4.1.1 Drilling dimensions

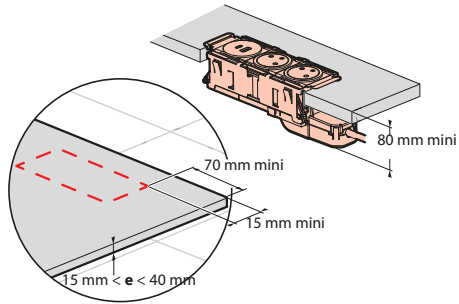

##### 4.1.2 Max cut-out radius in corners

##### 4.1.2.1 Sharp edges cut-out

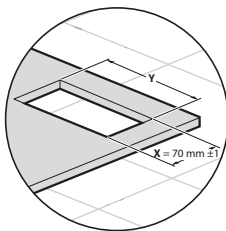

	Y ± 1mm
6 547 40/43/46/49	129,5
6 547 41/44/47/50	181,5
6 547 42/45/48/51	233,5

##### 4.1.2.2 CNC machining cut-out



X	R1 MAX	R2 MAX
76	12	6

#### 4. INSTALLATION (cont.)

##### 4.1.3 Insertion and fixing

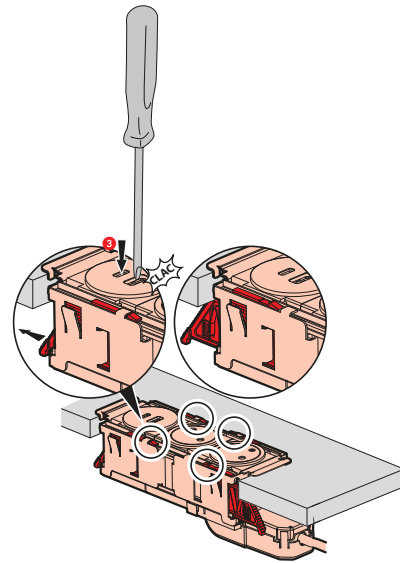
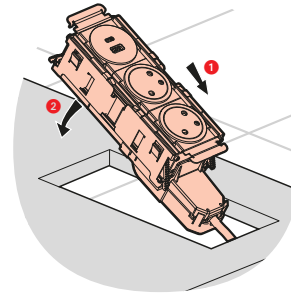

#### 5. TECHNICAL CHARACTERISTICS

##### ■ 5.1 Mechanical characteristics

Resistance to Impact : IK 07

Degree of protection provided by enclosures : IP 30

##### ■ 5.2 Material characteristics

- Wiring devices frames : Polycarbonate

- Housing:

. ABS

. galvanised steel (Z275)

. aluminium

- Finishes plates:

. Brushed aluminium + varnish

. Painted aluminium: black mat

. Painted aluminium: white satin

##### ■ 5.3 Electrical characteristics

##### 5.3.1 2 P+E sockets characteristics

- Supply voltage: 250V~

- Frequency: 50/60 Hz

- Rated current:

. for French & Schuko standards = 16A

. for British standard : individually fused = 5A

**5. TECHNICAL CHARACTERISTICS (cont.)**

**5.3.2 USB charger type (LXX15) :**

Trade mark	
Address	128, av. du Maréchal-de-Lattre-de-Tassigny - 87045 LIMOGES Cedex Tel. : 0 (+33) 5 55 06 87 87 Fax : 0 (+33) 5 55 06 88 88 www.legrand.com
Input voltage	110-240V
Input AC frequency	50-60Hz
Output voltage	5,0V
Output current	3,0A
Output power	15,0W
Average active efficiency	83,9%
Efficiency at low load (10%)	83,3%
No-load power consumption	0,06W

**5.3.3 Coupler RJ45 characteristics**

**5.3.3.1 Performance of link**

Standard performance at 20°C  
Following chart indicates maximal distances according to several configurations

CP Cord (C)	Maximum CP link (B)	TR Cord(s) (A)	Work Area Cord (D)	Total Channel
8 m	74 m	5 m	5 m	92 m
15 m	63 m			88 m
20 m	56 m			86 m

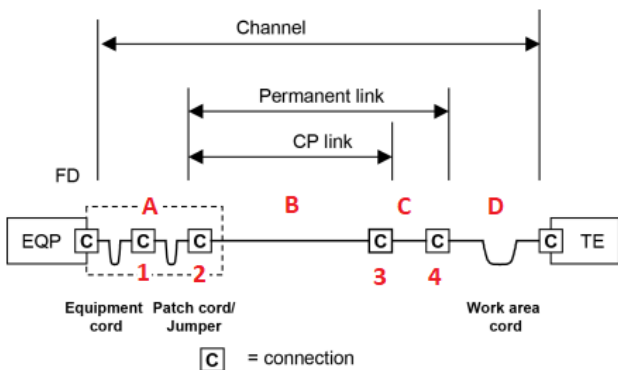

- 1 - Optional replication panel used only in specific 4-connector channels
- 2 - Panel
- 3 - Outlet (considered as a consolidation point)
- 4 - Incara Product (considered as an outlet in a 3-connector permanent link)

**5. TECHNICAL CHARACTERISTICS (cont.)**

**5.3.3.2 POE Compliances**

PoE++ type 1, 2, 3 and 4 according to 802.3 standard.

For more informations about performance with POE please refer to Legrand documentation (Legrand POE Guide)

**5.3.4 Cords characteristics :**

H05VV-F 3G 1.5mm<sup>2</sup>

**■ 5.4 Audio/Video characteristics (HDMI coupler)**

These values are subject to installation in accordance with good engineering practice and connection in compliance with current standards. Additional accessories and cords must comply with the same criteria.

**5.4.1 HDMI 1.4**

Maximum resolution (pixels) : 1080p

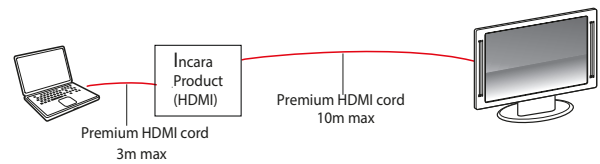

**5.4.2 HDMI 2.0**

Maximum resolution (pixels) : 2160p  
16/9 format: 2160 p, 60Hz, RGB  
21/9 format: 3840 x 2160p, 60Hz, RGB

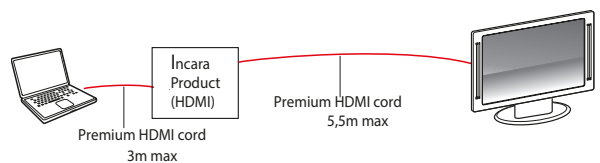

**■ 5.5 Climate characteristics**

Operating temperature : from -5°C to +35°C  
Storage temperature: from -10°C to +70°C

## 6. CLEANING

Superficial cleaning with a soft cloth. Do not use abrasive products or detergents

**Caution:** Always test before using other special cleaning products

## 7. STANDARDS & APPROVALS

Compliant to:

Standards			
French	Schuko	British	
		socket	complete product
NF C61-314 and IEC 60884-1	IEC 60884-1	BS 1363-2	BS 5733

USB charger compliant to IEC 62368-1

Products should be installed by competent persons to the current version of the local wiring regulations.  
Please consult Legrand locally for further details.